



Test Data

PCS3-220P-X2S

(AC(85)90~264V)

DC POWER SUPPLY

Approved by : H. Imai

Prepared by : A. Tatemura

INPUT : AC (85)90V ~ 264V

OUTPUT : V1: 5V 6A (Peak 15A)
V2: 3.3V 10A
V3: 12V 10A (Peak 12A)
V4: -12V 0.3A (Peak 0.8A)
V5: -5V 0.3A (Peak 0.5A)
V6: 5Vs 1.5A (Peak 2.5A)

株式会社 ニプロン
Nipron.Co.,Ltd.

CONTENTS

1. Line Regulation	1 ~ 3
2. Input Current (by Load Power)	4
3. Input Power (by Load Power)	5
4. Efficiency	6
5. Power Factor	7
6. Instantaneous Interruption Compensation (by Load Power)	8
7. Load Regulation	9 ~ 11
8. Ripple-Noise	12
9. Over-Current Protection	13
10. Over-Voltage Protection	14
11. Inrush Current	15
12. Dynamic Load Response	16 ~ 18
13. 12V Cross Regulation	19
14. Ambient Temperature Drift	20 ~ 22
15. Harmonic Current	23 ~ 24
16. Leakage Current	25
17. Line Noise Tolerance	26
18. Conducted Emission	27 ~ 28

Model	PCS3-220P-X2S																															
Item	Line Regulation																															
<p>V1:5V 6A</p> <p>at AC Input</p> <table border="1"> <thead> <tr> <th>Input Voltage [V]</th> <th>Output Voltage [V]</th> <th>Fluctuation Value [%]</th> </tr> </thead> <tbody> <tr><td>AC 90</td><td>4.998</td><td>-0.04</td></tr> <tr><td>100</td><td>4.998</td><td>-0.04</td></tr> <tr><td>240</td><td>4.998</td><td>-0.04</td></tr> <tr><td>264</td><td>4.998</td><td>-0.04</td></tr> </tbody> </table>		Input Voltage [V]	Output Voltage [V]	Fluctuation Value [%]	AC 90	4.998	-0.04	100	4.998	-0.04	240	4.998	-0.04	264	4.998	-0.04	<p>at AC Input</p> <table border="1"> <thead> <tr> <th>Input Voltage [V]</th> <th>Output Voltage [V]</th> <th>Fluctuation Value [%]</th> </tr> </thead> <tbody> <tr><td>AC 90</td><td>4.998</td><td>-0.04</td></tr> <tr><td>100</td><td>4.998</td><td>-0.04</td></tr> <tr><td>240</td><td>4.998</td><td>-0.04</td></tr> <tr><td>264</td><td>4.998</td><td>-0.04</td></tr> </tbody> </table>	Input Voltage [V]	Output Voltage [V]	Fluctuation Value [%]	AC 90	4.998	-0.04	100	4.998	-0.04	240	4.998	-0.04	264	4.998	-0.04
Input Voltage [V]	Output Voltage [V]	Fluctuation Value [%]																														
AC 90	4.998	-0.04																														
100	4.998	-0.04																														
240	4.998	-0.04																														
264	4.998	-0.04																														
Input Voltage [V]	Output Voltage [V]	Fluctuation Value [%]																														
AC 90	4.998	-0.04																														
100	4.998	-0.04																														
240	4.998	-0.04																														
264	4.998	-0.04																														
<p>V2:3.3V 10A</p> <p>at AC Input</p> <table border="1"> <thead> <tr> <th>Input Voltage [V]</th> <th>Output Voltage [V]</th> <th>Fluctuation Value [%]</th> </tr> </thead> <tbody> <tr><td>AC 90</td><td>3.275</td><td>-0.76</td></tr> <tr><td>100</td><td>3.275</td><td>-0.76</td></tr> <tr><td>240</td><td>3.274</td><td>-0.79</td></tr> <tr><td>264</td><td>3.274</td><td>-0.79</td></tr> </tbody> </table>		Input Voltage [V]	Output Voltage [V]	Fluctuation Value [%]	AC 90	3.275	-0.76	100	3.275	-0.76	240	3.274	-0.79	264	3.274	-0.79	<p>at AC Input</p> <table border="1"> <thead> <tr> <th>Input Voltage [V]</th> <th>Output Voltage [V]</th> <th>Fluctuation Value [%]</th> </tr> </thead> <tbody> <tr><td>AC 90</td><td>3.275</td><td>-0.76</td></tr> <tr><td>100</td><td>3.275</td><td>-0.76</td></tr> <tr><td>240</td><td>3.274</td><td>-0.79</td></tr> <tr><td>264</td><td>3.274</td><td>-0.79</td></tr> </tbody> </table>	Input Voltage [V]	Output Voltage [V]	Fluctuation Value [%]	AC 90	3.275	-0.76	100	3.275	-0.76	240	3.274	-0.79	264	3.274	-0.79
Input Voltage [V]	Output Voltage [V]	Fluctuation Value [%]																														
AC 90	3.275	-0.76																														
100	3.275	-0.76																														
240	3.274	-0.79																														
264	3.274	-0.79																														
Input Voltage [V]	Output Voltage [V]	Fluctuation Value [%]																														
AC 90	3.275	-0.76																														
100	3.275	-0.76																														
240	3.274	-0.79																														
264	3.274	-0.79																														

Model	PCS3-220P-X2S															
Item	Line Regulation															
<p>V3: 12V 10A</p> <p style="text-align: center;">at AC Input</p> <p style="text-align: center;">at AC Input</p> <table border="1"> <thead> <tr> <th>Input Voltage [V]</th> <th>Output Voltage [V]</th> <th>Fluctuation Value [%]</th> </tr> </thead> <tbody> <tr> <td>AC 90</td> <td>12.113</td> <td>0.94</td> </tr> <tr> <td>100</td> <td>12.111</td> <td>0.92</td> </tr> <tr> <td>240</td> <td>12.106</td> <td>0.88</td> </tr> <tr> <td>264</td> <td>12.105</td> <td>0.88</td> </tr> </tbody> </table>		Input Voltage [V]	Output Voltage [V]	Fluctuation Value [%]	AC 90	12.113	0.94	100	12.111	0.92	240	12.106	0.88	264	12.105	0.88
Input Voltage [V]	Output Voltage [V]	Fluctuation Value [%]														
AC 90	12.113	0.94														
100	12.111	0.92														
240	12.106	0.88														
264	12.105	0.88														
<p>V4: -12V 0.3A</p> <p style="text-align: center;">at AC Input</p> <p style="text-align: center;">at AC Input</p> <table border="1"> <thead> <tr> <th>Input Voltage [V]</th> <th>Output Voltage [V]</th> <th>Fluctuation Value [%]</th> </tr> </thead> <tbody> <tr> <td>AC 90</td> <td>-12.172</td> <td>1.43</td> </tr> <tr> <td>100</td> <td>-12.172</td> <td>1.43</td> </tr> <tr> <td>240</td> <td>-12.172</td> <td>1.43</td> </tr> <tr> <td>264</td> <td>-12.172</td> <td>1.43</td> </tr> </tbody> </table>		Input Voltage [V]	Output Voltage [V]	Fluctuation Value [%]	AC 90	-12.172	1.43	100	-12.172	1.43	240	-12.172	1.43	264	-12.172	1.43
Input Voltage [V]	Output Voltage [V]	Fluctuation Value [%]														
AC 90	-12.172	1.43														
100	-12.172	1.43														
240	-12.172	1.43														
264	-12.172	1.43														

Model	PCS3-220P-X2S															
Item	Line Regulation															
V5: -5V 0.3A																
<p style="text-align: center;">at AC Input</p> <p style="text-align: center;">at AC Input</p> <table border="1"> <thead> <tr> <th>Input Voltage [V]</th> <th>Output Voltage [V]</th> <th>Fluctuation Value [%]</th> </tr> </thead> <tbody> <tr> <td>AC 90</td> <td>-4.959</td> <td>-0.82</td> </tr> <tr> <td>100</td> <td>-4.959</td> <td>-0.82</td> </tr> <tr> <td>240</td> <td>-4.959</td> <td>-0.82</td> </tr> <tr> <td>264</td> <td>-4.959</td> <td>-0.82</td> </tr> </tbody> </table>		Input Voltage [V]	Output Voltage [V]	Fluctuation Value [%]	AC 90	-4.959	-0.82	100	-4.959	-0.82	240	-4.959	-0.82	264	-4.959	-0.82
Input Voltage [V]	Output Voltage [V]	Fluctuation Value [%]														
AC 90	-4.959	-0.82														
100	-4.959	-0.82														
240	-4.959	-0.82														
264	-4.959	-0.82														
V6: 5Vs 1.5A																
<p style="text-align: center;">at AC Input</p> <p style="text-align: center;">at AC Input</p> <table border="1"> <thead> <tr> <th>Input Voltage [V]</th> <th>Output Voltage [V]</th> <th>Fluctuation Value [%]</th> </tr> </thead> <tbody> <tr> <td>AC 90</td> <td>4.953</td> <td>-0.94</td> </tr> <tr> <td>100</td> <td>4.953</td> <td>-0.94</td> </tr> <tr> <td>240</td> <td>4.953</td> <td>-0.94</td> </tr> <tr> <td>264</td> <td>4.953</td> <td>-0.94</td> </tr> </tbody> </table>		Input Voltage [V]	Output Voltage [V]	Fluctuation Value [%]	AC 90	4.953	-0.94	100	4.953	-0.94	240	4.953	-0.94	264	4.953	-0.94
Input Voltage [V]	Output Voltage [V]	Fluctuation Value [%]														
AC 90	4.953	-0.94														
100	4.953	-0.94														
240	4.953	-0.94														
264	4.953	-0.94														

Model	PCS3-220P-X2S																																																																					
Item	Input Current (by Load Power)																																																																					
<p style="text-align: center;">at AC Input</p> <p style="text-align: center;">at AC Input</p> <table border="1"> <thead> <tr> <th rowspan="2">Load Power [W]</th> <th colspan="4">Input Current [A rms]</th> </tr> <tr> <th>Input Voltage AC90V</th> <th>Input Voltage AC100V</th> <th>Input Voltage AC240V</th> <th>Input Voltage AC264V</th> </tr> </thead> <tbody> <tr> <td>7.5</td> <td>0.34</td> <td>0.31</td> <td>0.19</td> <td>0.19</td> </tr> <tr> <td>48.9</td> <td>0.92</td> <td>0.82</td> <td>0.37</td> <td>0.37</td> </tr> <tr> <td>97.8</td> <td>1.60</td> <td>1.43</td> <td>0.62</td> <td>0.59</td> </tr> <tr> <td>146.7</td> <td>2.34</td> <td>2.08</td> <td>0.87</td> <td>0.82</td> </tr> <tr> <td>195.6</td> <td>3.13</td> <td>2.78</td> <td>1.13</td> <td>1.06</td> </tr> </tbody> </table>		Load Power [W]	Input Current [A rms]				Input Voltage AC90V	Input Voltage AC100V	Input Voltage AC240V	Input Voltage AC264V	7.5	0.34	0.31	0.19	0.19	48.9	0.92	0.82	0.37	0.37	97.8	1.60	1.43	0.62	0.59	146.7	2.34	2.08	0.87	0.82	195.6	3.13	2.78	1.13	1.06	<table border="1"> <thead> <tr> <th rowspan="2">Load Power [W]</th> <th colspan="4">Input Current [A rms]</th> </tr> <tr> <th>Input Voltage AC90V</th> <th>Input Voltage AC100V</th> <th>Input Voltage AC240V</th> <th>Input Voltage AC264V</th> </tr> </thead> <tbody> <tr> <td>7.5</td> <td>0.34</td> <td>0.31</td> <td>0.19</td> <td>0.19</td> </tr> <tr> <td>48.9</td> <td>0.92</td> <td>0.82</td> <td>0.37</td> <td>0.37</td> </tr> <tr> <td>97.8</td> <td>1.60</td> <td>1.43</td> <td>0.62</td> <td>0.59</td> </tr> <tr> <td>146.7</td> <td>2.34</td> <td>2.08</td> <td>0.87</td> <td>0.82</td> </tr> <tr> <td>195.6</td> <td>3.13</td> <td>2.78</td> <td>1.13</td> <td>1.06</td> </tr> </tbody> </table>	Load Power [W]	Input Current [A rms]				Input Voltage AC90V	Input Voltage AC100V	Input Voltage AC240V	Input Voltage AC264V	7.5	0.34	0.31	0.19	0.19	48.9	0.92	0.82	0.37	0.37	97.8	1.60	1.43	0.62	0.59	146.7	2.34	2.08	0.87	0.82	195.6	3.13	2.78	1.13	1.06
Load Power [W]	Input Current [A rms]																																																																					
	Input Voltage AC90V	Input Voltage AC100V	Input Voltage AC240V	Input Voltage AC264V																																																																		
7.5	0.34	0.31	0.19	0.19																																																																		
48.9	0.92	0.82	0.37	0.37																																																																		
97.8	1.60	1.43	0.62	0.59																																																																		
146.7	2.34	2.08	0.87	0.82																																																																		
195.6	3.13	2.78	1.13	1.06																																																																		
Load Power [W]	Input Current [A rms]																																																																					
	Input Voltage AC90V	Input Voltage AC100V	Input Voltage AC240V	Input Voltage AC264V																																																																		
7.5	0.34	0.31	0.19	0.19																																																																		
48.9	0.92	0.82	0.37	0.37																																																																		
97.8	1.60	1.43	0.62	0.59																																																																		
146.7	2.34	2.08	0.87	0.82																																																																		
195.6	3.13	2.78	1.13	1.06																																																																		

Model	PCS3-220P-X2S																																																																					
Item	Input Power (by Load Power)																																																																					
<p style="text-align: center;">at AC Input</p> <p style="text-align: center;">at AC Input</p> <table border="1"> <thead> <tr> <th rowspan="2">Load Power [W]</th> <th colspan="4">Input Power [W]</th> </tr> <tr> <th>Input Voltage AC90V</th> <th>Input Voltage AC100V</th> <th>Input Voltage AC240V</th> <th>Input Voltage AC264V</th> </tr> </thead> <tbody> <tr> <td>7.5</td> <td>30.09</td> <td>30.10</td> <td>29.29</td> <td>29.19</td> </tr> <tr> <td>48.9</td> <td>81.47</td> <td>81.00</td> <td>78.18</td> <td>77.93</td> </tr> <tr> <td>97.8</td> <td>143.09</td> <td>141.94</td> <td>136.72</td> <td>136.03</td> </tr> <tr> <td>146.7</td> <td>209.41</td> <td>207.12</td> <td>197.64</td> <td>196.91</td> </tr> <tr> <td>195.6</td> <td>279.94</td> <td>275.80</td> <td>260.72</td> <td>259.61</td> </tr> </tbody> </table>		Load Power [W]	Input Power [W]				Input Voltage AC90V	Input Voltage AC100V	Input Voltage AC240V	Input Voltage AC264V	7.5	30.09	30.10	29.29	29.19	48.9	81.47	81.00	78.18	77.93	97.8	143.09	141.94	136.72	136.03	146.7	209.41	207.12	197.64	196.91	195.6	279.94	275.80	260.72	259.61	<table border="1"> <thead> <tr> <th rowspan="2">Load Power [W]</th> <th colspan="4">Input Power [W]</th> </tr> <tr> <th>Input Voltage AC90V</th> <th>Input Voltage AC100V</th> <th>Input Voltage AC240V</th> <th>Input Voltage AC264V</th> </tr> </thead> <tbody> <tr> <td>7.5</td> <td>30.09</td> <td>30.10</td> <td>29.29</td> <td>29.19</td> </tr> <tr> <td>48.9</td> <td>81.47</td> <td>81.00</td> <td>78.18</td> <td>77.93</td> </tr> <tr> <td>97.8</td> <td>143.09</td> <td>141.94</td> <td>136.72</td> <td>136.03</td> </tr> <tr> <td>146.7</td> <td>209.41</td> <td>207.12</td> <td>197.64</td> <td>196.91</td> </tr> <tr> <td>195.6</td> <td>279.94</td> <td>275.80</td> <td>260.72</td> <td>259.61</td> </tr> </tbody> </table>	Load Power [W]	Input Power [W]				Input Voltage AC90V	Input Voltage AC100V	Input Voltage AC240V	Input Voltage AC264V	7.5	30.09	30.10	29.29	29.19	48.9	81.47	81.00	78.18	77.93	97.8	143.09	141.94	136.72	136.03	146.7	209.41	207.12	197.64	196.91	195.6	279.94	275.80	260.72	259.61
Load Power [W]	Input Power [W]																																																																					
	Input Voltage AC90V	Input Voltage AC100V	Input Voltage AC240V	Input Voltage AC264V																																																																		
7.5	30.09	30.10	29.29	29.19																																																																		
48.9	81.47	81.00	78.18	77.93																																																																		
97.8	143.09	141.94	136.72	136.03																																																																		
146.7	209.41	207.12	197.64	196.91																																																																		
195.6	279.94	275.80	260.72	259.61																																																																		
Load Power [W]	Input Power [W]																																																																					
	Input Voltage AC90V	Input Voltage AC100V	Input Voltage AC240V	Input Voltage AC264V																																																																		
7.5	30.09	30.10	29.29	29.19																																																																		
48.9	81.47	81.00	78.18	77.93																																																																		
97.8	143.09	141.94	136.72	136.03																																																																		
146.7	209.41	207.12	197.64	196.91																																																																		
195.6	279.94	275.80	260.72	259.61																																																																		

Model	PCS3-220P-X2S																															
Item	Efficiency																															
<p>at AC Input</p>		<p>at AC Input</p> <table border="1"> <thead> <tr> <th rowspan="2">Input Voltage [V]</th> <th colspan="2">Efficiency [%]</th> </tr> <tr> <th>50% Load</th> <th>100% Load</th> </tr> </thead> <tbody> <tr> <td>90</td> <td>69.03</td> <td>70.17</td> </tr> <tr> <td>100</td> <td>69.59</td> <td>71.22</td> </tr> <tr> <td>240</td> <td>72.24</td> <td>75.31</td> </tr> <tr> <td>264</td> <td>72.60</td> <td>75.63</td> </tr> </tbody> </table>		Input Voltage [V]	Efficiency [%]		50% Load	100% Load	90	69.03	70.17	100	69.59	71.22	240	72.24	75.31	264	72.60	75.63												
Input Voltage [V]	Efficiency [%]																															
	50% Load	100% Load																														
90	69.03	70.17																														
100	69.59	71.22																														
240	72.24	75.31																														
264	72.60	75.63																														
<p>at AC Input</p>		<p>at AC Input</p> <table border="1"> <thead> <tr> <th rowspan="2">Load Power [W]</th> <th colspan="4">Efficiency [%]</th> </tr> <tr> <th>Input Voltage AC90V</th> <th>Input Voltage AC100V</th> <th>Input Voltage AC240V</th> <th>Input Voltage AC264V</th> </tr> </thead> <tbody> <tr> <td>48.9</td> <td>60.75</td> <td>61.10</td> <td>63.31</td> <td>63.51</td> </tr> <tr> <td>97.8</td> <td>69.03</td> <td>69.59</td> <td>72.24</td> <td>72.60</td> </tr> <tr> <td>146.7</td> <td>70.61</td> <td>71.39</td> <td>74.82</td> <td>75.10</td> </tr> <tr> <td>195.6</td> <td>70.17</td> <td>71.22</td> <td>75.31</td> <td>75.63</td> </tr> </tbody> </table>		Load Power [W]	Efficiency [%]				Input Voltage AC90V	Input Voltage AC100V	Input Voltage AC240V	Input Voltage AC264V	48.9	60.75	61.10	63.31	63.51	97.8	69.03	69.59	72.24	72.60	146.7	70.61	71.39	74.82	75.10	195.6	70.17	71.22	75.31	75.63
Load Power [W]	Efficiency [%]																															
	Input Voltage AC90V	Input Voltage AC100V	Input Voltage AC240V	Input Voltage AC264V																												
48.9	60.75	61.10	63.31	63.51																												
97.8	69.03	69.59	72.24	72.60																												
146.7	70.61	71.39	74.82	75.10																												
195.6	70.17	71.22	75.31	75.63																												

Model	PCS3-220P-X2S																														
Item	Power Factor																														
<p style="text-align: center;">at AC Input</p> <p style="text-align: center;">at AC Input</p> <table border="1"> <thead> <tr> <th rowspan="2">Input Voltage [V]</th> <th colspan="2">Power Factor [%]</th> </tr> <tr> <th>50%Load</th> <th>100% Load</th> </tr> </thead> <tbody> <tr> <td>90</td> <td>99.17</td> <td>99.37</td> </tr> <tr> <td>100</td> <td>99.22</td> <td>99.31</td> </tr> <tr> <td>240</td> <td>92.54</td> <td>95.72</td> </tr> <tr> <td>264</td> <td>87.21</td> <td>93.01</td> </tr> </tbody> </table>		Input Voltage [V]	Power Factor [%]		50%Load	100% Load	90	99.17	99.37	100	99.22	99.31	240	92.54	95.72	264	87.21	93.01													
Input Voltage [V]	Power Factor [%]																														
	50%Load	100% Load																													
90	99.17	99.37																													
100	99.22	99.31																													
240	92.54	95.72																													
264	87.21	93.01																													
<p style="text-align: center;">at AC Input</p> <p style="text-align: center;">at AC Input</p> <table border="1"> <thead> <tr> <th rowspan="2">Load Power [W]</th> <th colspan="4">Power Factor [%]</th> </tr> <tr> <th>Input Voltage AC90V</th> <th>Input Voltage AC100V</th> <th>Input Voltage AC240V</th> <th>Input Voltage AC264V</th> </tr> </thead> <tbody> <tr> <td>48.9</td> <td>98.66</td> <td>98.82</td> <td>87.33</td> <td>79.08</td> </tr> <tr> <td>97.8</td> <td>99.17</td> <td>99.22</td> <td>92.54</td> <td>87.21</td> </tr> <tr> <td>146.7</td> <td>99.29</td> <td>99.38</td> <td>94.46</td> <td>90.94</td> </tr> <tr> <td>195.6</td> <td>99.37</td> <td>99.31</td> <td>95.72</td> <td>93.01</td> </tr> </tbody> </table>		Load Power [W]	Power Factor [%]				Input Voltage AC90V	Input Voltage AC100V	Input Voltage AC240V	Input Voltage AC264V	48.9	98.66	98.82	87.33	79.08	97.8	99.17	99.22	92.54	87.21	146.7	99.29	99.38	94.46	90.94	195.6	99.37	99.31	95.72	93.01	
Load Power [W]	Power Factor [%]																														
	Input Voltage AC90V	Input Voltage AC100V	Input Voltage AC240V	Input Voltage AC264V																											
48.9	98.66	98.82	87.33	79.08																											
97.8	99.17	99.22	92.54	87.21																											
146.7	99.29	99.38	94.46	90.94																											
195.6	99.37	99.31	95.72	93.01																											

Model	PCS3-220P-X2S
Item	Instantaneous Interruption Compensation (by Load Power)

at AC Input (85V / 100V / 240V / 264V)

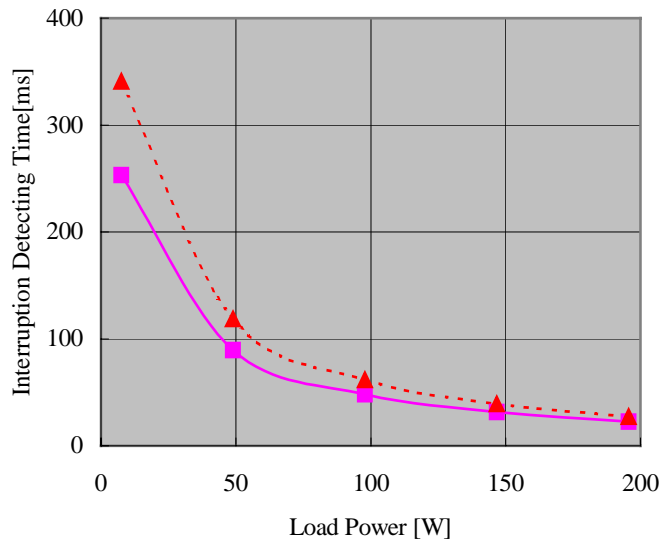
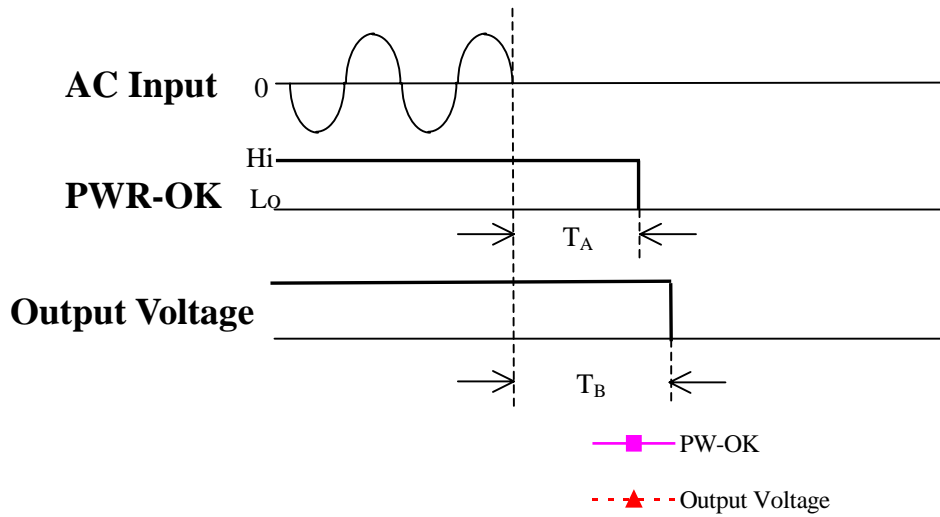

Load Power [W]	Interruption Detecting Time (ms)	
	PWR-OK TA	DC Output TB
7.5	253.20	340.90
48.6	89.50	118.58
97.8	48.29	61.67
146.7	31.53	39.12
195.6	22.51	27.17

Model	PCS3-220P-X2S																																																								
Item	Load Regulation																																																								
V1:5V 6A																																																									
<p>at AC Input</p> <p>Legend: AC90V (Blue square) AC100V (Magenta diamond) AC240V (Red triangle) AC264V (Green circle)</p>		<p>at AC Input</p> <table border="1"> <thead> <tr> <th rowspan="2">Load Power [W]</th> <th colspan="4">Fluctuation Value [%]</th> </tr> <tr> <th>Input Voltage AC90V</th> <th>Input Voltage AC100V</th> <th>Input Voltage AC240V</th> <th>Input Voltage AC264V</th> </tr> </thead> <tbody> <tr><td>7.5</td><td>1.44</td><td>1.44</td><td>1.44</td><td>1.44</td></tr> <tr><td>48.9</td><td>1.10</td><td>1.10</td><td>1.10</td><td>1.10</td></tr> <tr><td>97.8</td><td>0.74</td><td>0.74</td><td>0.76</td><td>0.74</td></tr> <tr><td>146.7</td><td>0.34</td><td>0.34</td><td>0.34</td><td>0.34</td></tr> <tr><td>195.6</td><td>-0.04</td><td>-0.04</td><td>-0.04</td><td>-0.04</td></tr> <tr><td>219.8</td><td>-0.86</td><td>-0.86</td><td>-0.92</td><td>-0.90</td></tr> </tbody> </table>	Load Power [W]	Fluctuation Value [%]				Input Voltage AC90V	Input Voltage AC100V	Input Voltage AC240V	Input Voltage AC264V	7.5	1.44	1.44	1.44	1.44	48.9	1.10	1.10	1.10	1.10	97.8	0.74	0.74	0.76	0.74	146.7	0.34	0.34	0.34	0.34	195.6	-0.04	-0.04	-0.04	-0.04	219.8	-0.86	-0.86	-0.92	-0.90																
Load Power [W]	Fluctuation Value [%]																																																								
	Input Voltage AC90V	Input Voltage AC100V	Input Voltage AC240V	Input Voltage AC264V																																																					
7.5	1.44	1.44	1.44	1.44																																																					
48.9	1.10	1.10	1.10	1.10																																																					
97.8	0.74	0.74	0.76	0.74																																																					
146.7	0.34	0.34	0.34	0.34																																																					
195.6	-0.04	-0.04	-0.04	-0.04																																																					
219.8	-0.86	-0.86	-0.92	-0.90																																																					
		<table border="1"> <thead> <tr> <th rowspan="2">Load Power [W]</th> <th colspan="6">Load Current [A]</th> </tr> <tr> <th>5V</th> <th>3.3V</th> <th>12V</th> <th>-12V</th> <th>-5V</th> <th>5Vs</th> </tr> </thead> <tbody> <tr><td>7.5</td><td>1.5</td><td>0</td><td>0</td><td>0</td><td>0</td><td>0</td></tr> <tr><td>48.9</td><td>1.5</td><td>2.5</td><td>2.5</td><td>0.08</td><td>0.08</td><td>0.38</td></tr> <tr><td>97.8</td><td>3</td><td>5</td><td>5</td><td>0.15</td><td>0.15</td><td>0.75</td></tr> <tr><td>146.7</td><td>4.5</td><td>7.5</td><td>7.5</td><td>0.23</td><td>0.23</td><td>1.13</td></tr> <tr><td>195.6</td><td>6</td><td>10</td><td>10</td><td>0.3</td><td>0.3</td><td>1.5</td></tr> <tr><td>219.8</td><td>15</td><td>0</td><td>10.4</td><td>0.5</td><td>0.3</td><td>2.5</td></tr> </tbody> </table>	Load Power [W]	Load Current [A]						5V	3.3V	12V	-12V	-5V	5Vs	7.5	1.5	0	0	0	0	0	48.9	1.5	2.5	2.5	0.08	0.08	0.38	97.8	3	5	5	0.15	0.15	0.75	146.7	4.5	7.5	7.5	0.23	0.23	1.13	195.6	6	10	10	0.3	0.3	1.5	219.8	15	0	10.4	0.5	0.3	2.5
Load Power [W]	Load Current [A]																																																								
	5V	3.3V	12V	-12V	-5V	5Vs																																																			
7.5	1.5	0	0	0	0	0																																																			
48.9	1.5	2.5	2.5	0.08	0.08	0.38																																																			
97.8	3	5	5	0.15	0.15	0.75																																																			
146.7	4.5	7.5	7.5	0.23	0.23	1.13																																																			
195.6	6	10	10	0.3	0.3	1.5																																																			
219.8	15	0	10.4	0.5	0.3	2.5																																																			
V2:3.3V 10A																																																									
<p>at AC Input</p> <p>Legend: AC90V (Blue square) AC100V (Magenta diamond) AC240V (Red triangle) AC264V (Green circle)</p>		<p>at AC Input</p> <table border="1"> <thead> <tr> <th rowspan="2">Load Power [W]</th> <th colspan="4">Fluctuation Value [%]</th> </tr> <tr> <th>Input Voltage AC90V</th> <th>Input Voltage AC100V</th> <th>Input Voltage AC240V</th> <th>Input Voltage AC264V</th> </tr> </thead> <tbody> <tr><td>7.5</td><td>1.24</td><td>1.24</td><td>1.24</td><td>1.24</td></tr> <tr><td>48.9</td><td>0.73</td><td>0.73</td><td>0.73</td><td>0.73</td></tr> <tr><td>97.8</td><td>0.21</td><td>0.21</td><td>0.21</td><td>0.21</td></tr> <tr><td>146.7</td><td>-0.33</td><td>-0.30</td><td>-0.30</td><td>-0.30</td></tr> <tr><td>195.6</td><td>-0.76</td><td>-0.76</td><td>-0.79</td><td>-0.79</td></tr> <tr><td>212.8</td><td>-0.67</td><td>-0.70</td><td>-0.61</td><td>-0.61</td></tr> </tbody> </table>	Load Power [W]	Fluctuation Value [%]				Input Voltage AC90V	Input Voltage AC100V	Input Voltage AC240V	Input Voltage AC264V	7.5	1.24	1.24	1.24	1.24	48.9	0.73	0.73	0.73	0.73	97.8	0.21	0.21	0.21	0.21	146.7	-0.33	-0.30	-0.30	-0.30	195.6	-0.76	-0.76	-0.79	-0.79	212.8	-0.67	-0.70	-0.61	-0.61																
Load Power [W]	Fluctuation Value [%]																																																								
	Input Voltage AC90V	Input Voltage AC100V	Input Voltage AC240V	Input Voltage AC264V																																																					
7.5	1.24	1.24	1.24	1.24																																																					
48.9	0.73	0.73	0.73	0.73																																																					
97.8	0.21	0.21	0.21	0.21																																																					
146.7	-0.33	-0.30	-0.30	-0.30																																																					
195.6	-0.76	-0.76	-0.79	-0.79																																																					
212.8	-0.67	-0.70	-0.61	-0.61																																																					
		<table border="1"> <thead> <tr> <th rowspan="2">Load Power [W]</th> <th colspan="6">Load Current [A]</th> </tr> <tr> <th>5V</th> <th>3.3V</th> <th>12V</th> <th>-12V</th> <th>-5V</th> <th>5Vs</th> </tr> </thead> <tbody> <tr><td>7.5</td><td>1.5</td><td>0</td><td>0</td><td>0</td><td>0</td><td>0</td></tr> <tr><td>48.9</td><td>1.5</td><td>2.5</td><td>2.5</td><td>0.08</td><td>0.08</td><td>0.38</td></tr> <tr><td>97.8</td><td>3</td><td>5</td><td>5</td><td>0.15</td><td>0.15</td><td>0.75</td></tr> <tr><td>146.7</td><td>4.5</td><td>7.5</td><td>7.5</td><td>0.23</td><td>0.23</td><td>1.13</td></tr> <tr><td>195.6</td><td>6</td><td>10</td><td>10</td><td>0.3</td><td>0.3</td><td>1.5</td></tr> <tr><td>212.8</td><td>7</td><td>10</td><td>10.4</td><td>0.5</td><td>0.3</td><td>2.5</td></tr> </tbody> </table>	Load Power [W]	Load Current [A]						5V	3.3V	12V	-12V	-5V	5Vs	7.5	1.5	0	0	0	0	0	48.9	1.5	2.5	2.5	0.08	0.08	0.38	97.8	3	5	5	0.15	0.15	0.75	146.7	4.5	7.5	7.5	0.23	0.23	1.13	195.6	6	10	10	0.3	0.3	1.5	212.8	7	10	10.4	0.5	0.3	2.5
Load Power [W]	Load Current [A]																																																								
	5V	3.3V	12V	-12V	-5V	5Vs																																																			
7.5	1.5	0	0	0	0	0																																																			
48.9	1.5	2.5	2.5	0.08	0.08	0.38																																																			
97.8	3	5	5	0.15	0.15	0.75																																																			
146.7	4.5	7.5	7.5	0.23	0.23	1.13																																																			
195.6	6	10	10	0.3	0.3	1.5																																																			
212.8	7	10	10.4	0.5	0.3	2.5																																																			

Model	PCS3-220P-X2S																																																								
Item	Load Regulation																																																								
V3: 12V 10A																																																									
<p style="text-align: center;">at AC Input</p> <p style="text-align: center;">Fluctuation Value [%]</p> <p style="text-align: center;">Load Power [W]</p>		<p style="text-align: center;">at AC Input</p> <table border="1"> <thead> <tr> <th rowspan="2">Load Power [W]</th> <th colspan="4">Fluctuation Value [%]</th> </tr> <tr> <th>Input Voltage AC90V</th> <th>Input Voltage AC100V</th> <th>Input Voltage AC240V</th> <th>Input Voltage AC264V</th> </tr> </thead> <tbody> <tr><td>7.5</td><td>1.88</td><td>1.88</td><td>1.88</td><td>1.88</td></tr> <tr><td>48.9</td><td>1.45</td><td>1.45</td><td>1.45</td><td>1.45</td></tr> <tr><td>97.8</td><td>1.35</td><td>1.35</td><td>1.33</td><td>1.33</td></tr> <tr><td>146.7</td><td>1.29</td><td>1.29</td><td>1.30</td><td>1.30</td></tr> <tr><td>195.6</td><td>0.94</td><td>0.92</td><td>0.88</td><td>0.88</td></tr> <tr><td>219.74</td><td>1.08</td><td>1.17</td><td>1.08</td><td>0.92</td></tr> </tbody> </table>	Load Power [W]	Fluctuation Value [%]				Input Voltage AC90V	Input Voltage AC100V	Input Voltage AC240V	Input Voltage AC264V	7.5	1.88	1.88	1.88	1.88	48.9	1.45	1.45	1.45	1.45	97.8	1.35	1.35	1.33	1.33	146.7	1.29	1.29	1.30	1.30	195.6	0.94	0.92	0.88	0.88	219.74	1.08	1.17	1.08	0.92																
Load Power [W]	Fluctuation Value [%]																																																								
	Input Voltage AC90V	Input Voltage AC100V	Input Voltage AC240V	Input Voltage AC264V																																																					
7.5	1.88	1.88	1.88	1.88																																																					
48.9	1.45	1.45	1.45	1.45																																																					
97.8	1.35	1.35	1.33	1.33																																																					
146.7	1.29	1.29	1.30	1.30																																																					
195.6	0.94	0.92	0.88	0.88																																																					
219.74	1.08	1.17	1.08	0.92																																																					
		<table border="1"> <thead> <tr> <th rowspan="2">Load Power [W]</th> <th colspan="6">Load Current [A]</th> </tr> <tr> <th>5V</th> <th>3.3V</th> <th>12V</th> <th>-12V</th> <th>-5V</th> <th>5Vs</th> </tr> </thead> <tbody> <tr><td>7.5</td><td>1.5</td><td>0</td><td>0</td><td>0</td><td>0</td><td>0</td></tr> <tr><td>48.9</td><td>1.5</td><td>2.5</td><td>2.5</td><td>0.08</td><td>0.08</td><td>0.38</td></tr> <tr><td>97.8</td><td>3</td><td>5</td><td>5</td><td>0.15</td><td>0.15</td><td>0.75</td></tr> <tr><td>146.7</td><td>4.5</td><td>7.5</td><td>7.5</td><td>0.23</td><td>0.23</td><td>1.13</td></tr> <tr><td>195.6</td><td>6</td><td>10</td><td>10</td><td>0.3</td><td>0.3</td><td>1.5</td></tr> <tr><td>219.74</td><td>6</td><td>7.8</td><td>12</td><td>0.5</td><td>0.3</td><td>2.5</td></tr> </tbody> </table>	Load Power [W]	Load Current [A]						5V	3.3V	12V	-12V	-5V	5Vs	7.5	1.5	0	0	0	0	0	48.9	1.5	2.5	2.5	0.08	0.08	0.38	97.8	3	5	5	0.15	0.15	0.75	146.7	4.5	7.5	7.5	0.23	0.23	1.13	195.6	6	10	10	0.3	0.3	1.5	219.74	6	7.8	12	0.5	0.3	2.5
Load Power [W]	Load Current [A]																																																								
	5V	3.3V	12V	-12V	-5V	5Vs																																																			
7.5	1.5	0	0	0	0	0																																																			
48.9	1.5	2.5	2.5	0.08	0.08	0.38																																																			
97.8	3	5	5	0.15	0.15	0.75																																																			
146.7	4.5	7.5	7.5	0.23	0.23	1.13																																																			
195.6	6	10	10	0.3	0.3	1.5																																																			
219.74	6	7.8	12	0.5	0.3	2.5																																																			
V4: -12V 0.3A																																																									
<p style="text-align: center;">at AC Input</p> <p style="text-align: center;">Fluctuation Value [%]</p> <p style="text-align: center;">Load Power [W]</p>		<p style="text-align: center;">at AC Input</p> <table border="1"> <thead> <tr> <th rowspan="2">Load Power [W]</th> <th colspan="4">Fluctuation Value [%]</th> </tr> <tr> <th>Input Voltage AC90V</th> <th>Input Voltage AC100V</th> <th>Input Voltage AC240V</th> <th>Input Voltage AC264V</th> </tr> </thead> <tbody> <tr><td>7.5</td><td>1.09</td><td>1.09</td><td>1.09</td><td>1.09</td></tr> <tr><td>48.9</td><td>1.18</td><td>1.18</td><td>1.17</td><td>1.17</td></tr> <tr><td>97.8</td><td>1.25</td><td>1.26</td><td>1.26</td><td>1.26</td></tr> <tr><td>146.7</td><td>1.34</td><td>1.35</td><td>1.35</td><td>1.35</td></tr> <tr><td>195.6</td><td>1.43</td><td>1.43</td><td>1.43</td><td>1.43</td></tr> <tr><td>205.1</td><td>1.25</td><td>1.25</td><td>1.25</td><td>1.25</td></tr> </tbody> </table>	Load Power [W]	Fluctuation Value [%]				Input Voltage AC90V	Input Voltage AC100V	Input Voltage AC240V	Input Voltage AC264V	7.5	1.09	1.09	1.09	1.09	48.9	1.18	1.18	1.17	1.17	97.8	1.25	1.26	1.26	1.26	146.7	1.34	1.35	1.35	1.35	195.6	1.43	1.43	1.43	1.43	205.1	1.25	1.25	1.25	1.25																
Load Power [W]	Fluctuation Value [%]																																																								
	Input Voltage AC90V	Input Voltage AC100V	Input Voltage AC240V	Input Voltage AC264V																																																					
7.5	1.09	1.09	1.09	1.09																																																					
48.9	1.18	1.18	1.17	1.17																																																					
97.8	1.25	1.26	1.26	1.26																																																					
146.7	1.34	1.35	1.35	1.35																																																					
195.6	1.43	1.43	1.43	1.43																																																					
205.1	1.25	1.25	1.25	1.25																																																					
		<table border="1"> <thead> <tr> <th rowspan="2">Load Power [W]</th> <th colspan="6">Load Current [A]</th> </tr> <tr> <th>5V</th> <th>3.3V</th> <th>12V</th> <th>-12V</th> <th>-5V</th> <th>5Vs</th> </tr> </thead> <tbody> <tr><td>7.5</td><td>1.5</td><td>0</td><td>0</td><td>0</td><td>0</td><td>0</td></tr> <tr><td>48.9</td><td>1.5</td><td>2.5</td><td>2.5</td><td>0.08</td><td>0.08</td><td>0.38</td></tr> <tr><td>97.8</td><td>3</td><td>5</td><td>5</td><td>0.15</td><td>0.15</td><td>0.75</td></tr> <tr><td>146.7</td><td>4.5</td><td>7.5</td><td>7.5</td><td>0.23</td><td>0.23</td><td>1.13</td></tr> <tr><td>195.6</td><td>6</td><td>10</td><td>10</td><td>0.3</td><td>0.3</td><td>1.5</td></tr> <tr><td>205.1</td><td>6</td><td>10</td><td>10</td><td>0.8</td><td>0</td><td>2.5</td></tr> </tbody> </table>	Load Power [W]	Load Current [A]						5V	3.3V	12V	-12V	-5V	5Vs	7.5	1.5	0	0	0	0	0	48.9	1.5	2.5	2.5	0.08	0.08	0.38	97.8	3	5	5	0.15	0.15	0.75	146.7	4.5	7.5	7.5	0.23	0.23	1.13	195.6	6	10	10	0.3	0.3	1.5	205.1	6	10	10	0.8	0	2.5
Load Power [W]	Load Current [A]																																																								
	5V	3.3V	12V	-12V	-5V	5Vs																																																			
7.5	1.5	0	0	0	0	0																																																			
48.9	1.5	2.5	2.5	0.08	0.08	0.38																																																			
97.8	3	5	5	0.15	0.15	0.75																																																			
146.7	4.5	7.5	7.5	0.23	0.23	1.13																																																			
195.6	6	10	10	0.3	0.3	1.5																																																			
205.1	6	10	10	0.8	0	2.5																																																			

Model	PCS3-220P-X2S																																																								
Item	Load Regulation																																																								
V5: -5V 0.3A																																																									
<p>at AC Input</p>		<p>at AC Input</p> <table border="1"> <thead> <tr> <th rowspan="2">Load Power [W]</th> <th colspan="4">Fluctuation Value [%]</th> </tr> <tr> <th>Input Voltage AC90V</th> <th>Input Voltage AC100V</th> <th>Input Voltage AC240V</th> <th>Input Voltage AC264V</th> </tr> </thead> <tbody> <tr><td>7.5</td><td>-1.40</td><td>-1.40</td><td>-1.40</td><td>-1.40</td></tr> <tr><td>48.9</td><td>-1.30</td><td>-1.30</td><td>-1.32</td><td>-1.32</td></tr> <tr><td>97.8</td><td>-1.16</td><td>-1.16</td><td>-1.14</td><td>-1.14</td></tr> <tr><td>146.7</td><td>-0.98</td><td>-0.98</td><td>-0.98</td><td>-0.98</td></tr> <tr><td>195.6</td><td>-0.82</td><td>-0.82</td><td>-0.82</td><td>-0.82</td></tr> <tr><td>205.08</td><td>-1.00</td><td>-1.00</td><td>-1.20</td><td>-1.00</td></tr> </tbody> </table>	Load Power [W]	Fluctuation Value [%]				Input Voltage AC90V	Input Voltage AC100V	Input Voltage AC240V	Input Voltage AC264V	7.5	-1.40	-1.40	-1.40	-1.40	48.9	-1.30	-1.30	-1.32	-1.32	97.8	-1.16	-1.16	-1.14	-1.14	146.7	-0.98	-0.98	-0.98	-0.98	195.6	-0.82	-0.82	-0.82	-0.82	205.08	-1.00	-1.00	-1.20	-1.00																
Load Power [W]	Fluctuation Value [%]																																																								
	Input Voltage AC90V	Input Voltage AC100V	Input Voltage AC240V	Input Voltage AC264V																																																					
7.5	-1.40	-1.40	-1.40	-1.40																																																					
48.9	-1.30	-1.30	-1.32	-1.32																																																					
97.8	-1.16	-1.16	-1.14	-1.14																																																					
146.7	-0.98	-0.98	-0.98	-0.98																																																					
195.6	-0.82	-0.82	-0.82	-0.82																																																					
205.08	-1.00	-1.00	-1.20	-1.00																																																					
		<p>Load Condition</p> <table border="1"> <thead> <tr> <th rowspan="2">Load Power [W]</th> <th colspan="6">Load Current [A]</th> </tr> <tr> <th>5V</th> <th>3.3V</th> <th>12V</th> <th>-12V</th> <th>-5V</th> <th>5Vs</th> </tr> </thead> <tbody> <tr><td>7.5</td><td>1.5</td><td>0</td><td>0</td><td>0</td><td>0</td><td>0</td></tr> <tr><td>48.9</td><td>1.5</td><td>2.5</td><td>2.5</td><td>0.08</td><td>0.08</td><td>0.38</td></tr> <tr><td>97.8</td><td>3</td><td>5</td><td>5</td><td>0.15</td><td>0.15</td><td>0.75</td></tr> <tr><td>146.7</td><td>4.5</td><td>7.5</td><td>7.5</td><td>0.23</td><td>0.23</td><td>1.13</td></tr> <tr><td>195.6</td><td>6</td><td>10</td><td>10</td><td>0.3</td><td>0.3</td><td>1.5</td></tr> <tr><td>205.08</td><td>6</td><td>10</td><td>10</td><td>0.59</td><td>0.5</td><td>2.5</td></tr> </tbody> </table>	Load Power [W]	Load Current [A]						5V	3.3V	12V	-12V	-5V	5Vs	7.5	1.5	0	0	0	0	0	48.9	1.5	2.5	2.5	0.08	0.08	0.38	97.8	3	5	5	0.15	0.15	0.75	146.7	4.5	7.5	7.5	0.23	0.23	1.13	195.6	6	10	10	0.3	0.3	1.5	205.08	6	10	10	0.59	0.5	2.5
Load Power [W]	Load Current [A]																																																								
	5V	3.3V	12V	-12V	-5V	5Vs																																																			
7.5	1.5	0	0	0	0	0																																																			
48.9	1.5	2.5	2.5	0.08	0.08	0.38																																																			
97.8	3	5	5	0.15	0.15	0.75																																																			
146.7	4.5	7.5	7.5	0.23	0.23	1.13																																																			
195.6	6	10	10	0.3	0.3	1.5																																																			
205.08	6	10	10	0.59	0.5	2.5																																																			
V6: 5Vs 1.5A																																																									
<p>at AC Input</p>		<p>at AC Input</p> <table border="1"> <thead> <tr> <th rowspan="2">Load Power [W]</th> <th colspan="4">Fluctuation Value [%]</th> </tr> <tr> <th>Input Voltage AC90V</th> <th>Input Voltage AC100V</th> <th>Input Voltage AC240V</th> <th>Input Voltage AC264V</th> </tr> </thead> <tbody> <tr><td>7.5</td><td>1.12</td><td>1.12</td><td>1.12</td><td>1.12</td></tr> <tr><td>48.9</td><td>0.60</td><td>0.60</td><td>0.60</td><td>0.60</td></tr> <tr><td>97.8</td><td>0.14</td><td>0.10</td><td>0.12</td><td>0.08</td></tr> <tr><td>146.7</td><td>-0.44</td><td>-0.44</td><td>-0.44</td><td>-0.44</td></tr> <tr><td>195.6</td><td>-0.94</td><td>-0.94</td><td>-0.94</td><td>-0.94</td></tr> <tr><td>219.8</td><td>-2.30</td><td>-2.30</td><td>-2.26</td><td>-2.22</td></tr> </tbody> </table>	Load Power [W]	Fluctuation Value [%]				Input Voltage AC90V	Input Voltage AC100V	Input Voltage AC240V	Input Voltage AC264V	7.5	1.12	1.12	1.12	1.12	48.9	0.60	0.60	0.60	0.60	97.8	0.14	0.10	0.12	0.08	146.7	-0.44	-0.44	-0.44	-0.44	195.6	-0.94	-0.94	-0.94	-0.94	219.8	-2.30	-2.30	-2.26	-2.22																
Load Power [W]	Fluctuation Value [%]																																																								
	Input Voltage AC90V	Input Voltage AC100V	Input Voltage AC240V	Input Voltage AC264V																																																					
7.5	1.12	1.12	1.12	1.12																																																					
48.9	0.60	0.60	0.60	0.60																																																					
97.8	0.14	0.10	0.12	0.08																																																					
146.7	-0.44	-0.44	-0.44	-0.44																																																					
195.6	-0.94	-0.94	-0.94	-0.94																																																					
219.8	-2.30	-2.30	-2.26	-2.22																																																					
		<p>Load Condition</p> <table border="1"> <thead> <tr> <th rowspan="2">Load Power [W]</th> <th colspan="6">Load Current [A]</th> </tr> <tr> <th>5V</th> <th>3.3V</th> <th>12V</th> <th>-12V</th> <th>-5V</th> <th>5Vs</th> </tr> </thead> <tbody> <tr><td>7.5</td><td>1.5</td><td>0</td><td>0</td><td>0</td><td>0</td><td>0</td></tr> <tr><td>48.9</td><td>1.5</td><td>2.5</td><td>2.5</td><td>0.08</td><td>0.08</td><td>0.38</td></tr> <tr><td>97.8</td><td>3</td><td>5</td><td>5</td><td>0.15</td><td>0.15</td><td>0.75</td></tr> <tr><td>146.7</td><td>4.5</td><td>7.5</td><td>7.5</td><td>0.23</td><td>0.23</td><td>1.13</td></tr> <tr><td>195.6</td><td>6</td><td>10</td><td>10</td><td>0.3</td><td>0.3</td><td>1.5</td></tr> <tr><td>219.8</td><td>15</td><td>0</td><td>10.4</td><td>0.5</td><td>0.3</td><td>2.5</td></tr> </tbody> </table>	Load Power [W]	Load Current [A]						5V	3.3V	12V	-12V	-5V	5Vs	7.5	1.5	0	0	0	0	0	48.9	1.5	2.5	2.5	0.08	0.08	0.38	97.8	3	5	5	0.15	0.15	0.75	146.7	4.5	7.5	7.5	0.23	0.23	1.13	195.6	6	10	10	0.3	0.3	1.5	219.8	15	0	10.4	0.5	0.3	2.5
Load Power [W]	Load Current [A]																																																								
	5V	3.3V	12V	-12V	-5V	5Vs																																																			
7.5	1.5	0	0	0	0	0																																																			
48.9	1.5	2.5	2.5	0.08	0.08	0.38																																																			
97.8	3	5	5	0.15	0.15	0.75																																																			
146.7	4.5	7.5	7.5	0.23	0.23	1.13																																																			
195.6	6	10	10	0.3	0.3	1.5																																																			
219.8	15	0	10.4	0.5	0.3	2.5																																																			

Model	PCS3-220P-X2S
Item	Ripple / Noise Voltage Test

Temperature	Input Voltage	V1	5V	V2	3.3V	V3	12V
		Ripple (mV)	Noise (mV)	Ripple (mV)	Noise (mV)	Ripple (mV)	Noise (mV)
-5	90 V	24	/ 34	28	/ 40	16	/ 26
	100 V	24	/ 30	28	/ 36	16	/ 24
	240 V	20	/ 24	28	/ 32	16	/ 20
	264 V	20	/ 24	28	/ 32	16	/ 20
25	90 V	16	/ 18	16	/ 28	16	/ 30
	100 V	16	/ 18	16	/ 28	16	/ 30
	240 V	16	/ 18	16	/ 28	16	/ 30
	264 V	16	/ 18	16	/ 28	16	/ 30
45	90 V	16	/ 24	16	/ 24	12	/ 28
	100 V	16	/ 24	16	/ 24	12	/ 28
	240 V	16	/ 20	16	/ 24	12	/ 26
	264 V	16	/ 20	16	/ 24	12	/ 26
Specification		50	/ 100	50	/ 100	120	/ 170
Judgment		Good		Good		Good	

Temperature	Input Voltage	V4	-12V	V5	-5V	V6	5VS
		Ripple (mV)	Noise (mV)	Ripple (mV)	Noise (mV)	Ripple (mV)	Noise (mV)
-5	90 V	10	/ 20	6	/ 16	12	/ 34
	100 V	10	/ 20	6	/ 16	12	/ 30
	240 V	10	/ 20	6	/ 16	12	/ 30
	264 V	10	/ 20	6	/ 16	12	/ 30
25	90 V	8	/ 12	4	/ 10	12	/ 30
	100 V	8	/ 12	4	/ 10	12	/ 30
	240 V	8	/ 12	4	/ 10	12	/ 30
	264 V	8	/ 12	4	/ 10	12	/ 30
45	90 V	8	/ 20	4	/ 12	12	/ 32
	100 V	8	/ 20	4	/ 12	12	/ 32
	240 V	8	/ 20	4	/ 12	12	/ 36
	264 V	8	/ 20	4	/ 12	12	/ 36
Specification		120	/ 170	100	/ 150	50	/ 100
Judgment		Good		Good		Good	

Model	PCS3-220P-X2S
Item	Over-Current Protection

Temperature	Input Voltage	V1 5V	V2 3.3V	V3 12V
-5	90 V	13.8 A	17.5 A	13.4 A
	100 V	13.8 A	17.5 A	13.3 A
	240 V	13.8 A	17.5 A	13.3 A
	264 V	13.8 A	17.5 A	13.2 A
25	90 V	12.9 A	17.0 A	13.5 A
	100 V	13.0 A	17.0 A	13.5 A
	240 V	13.1 A	17.0 A	13.4 A
	264 V	13.2 A	17.0 A	13.4 A
45	90 V	12.7 A	16.5 A	13.4 A
	100 V	12.7 A	16.5 A	13.4 A
	240 V	12.7 A	16.5 A	13.0 A
	264 V	12.7 A	16.5 A	13.0 A
Specification		7A or More	11A or More	13A or More
Judgment		Good	Good	Good

Temperature	Input Voltage	V4 -12V	V5 -5V	V6 5VS
-5	90 V	1.75 A	0.90 A	3.80 A
	100 V	1.75 A	0.92 A	3.80 A
	240 V	1.75 A	0.92 A	3.70 A
	264 V	1.75 A	0.88 A	3.70 A
25	90 V	1.65 A	0.82 A	3.60 A
	100 V	1.60 A	0.82 A	3.60 A
	240 V	1.55 A	0.82 A	3.60 A
	264 V	1.60 A	0.82 A	3.60 A
45	90 V	1.45 A	0.79 A	3.40 A
	100 V	1.54 A	0.80 A	3.40 A
	240 V	1.52 A	0.79 A	3.40 A
	264 V	1.54 A	0.80 A	3.40 A
Specification		-	-	-
Judgment		-	-	-

Model	PCS3-220P-X2S
Item	Over-Voltage Protection

Temperature	Input Voltage	V1:5V	V2:3.3V	V3:12V
-5	AC100V	6.67V	4.23V	14.74V
	AC240V	6.67V	4.23V	14.75V
25	AC100V	6.51V	4.02V	14.81V
	AC240V	6.50V	4.02V	14.81V
45	AC100V	6.40V	3.88V	14.83V
	AC240V	6.40V	3.88V	14.83V
Specification		5.76 ~ 7.0V	3.74 ~ 4.3V	13.4 ~ 15.6V
Judgment		Good	Good	Good

Model	PCS3-220P-X2S
Item	Inrush Current

Inrush Current Wave

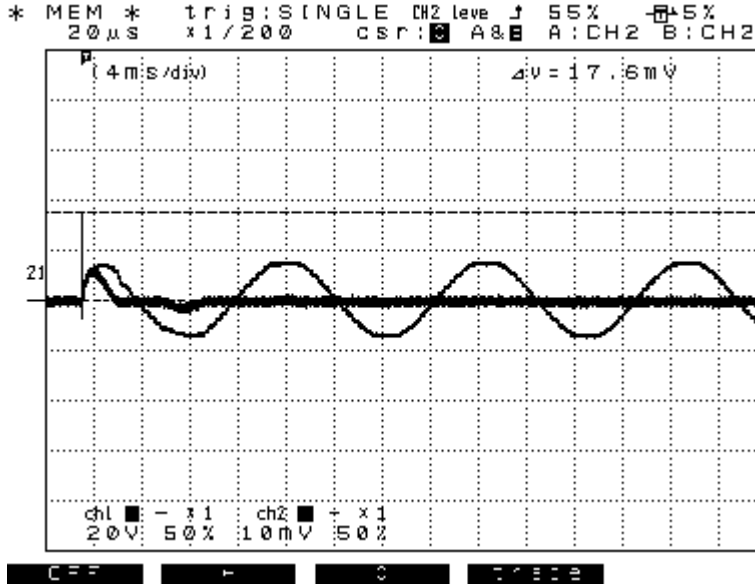

Wave No.1	
CH1	Measuring Point : Input Voltage
	Range 200V/DIV
CH2	Measuring Point : Input Current
	Range 20A/DIV
Time Line	5ms/DIV
Conditions	Input : AC100V 60Hz Load : Rated Load
Note :	
Inrush Current Value : 35.2A	

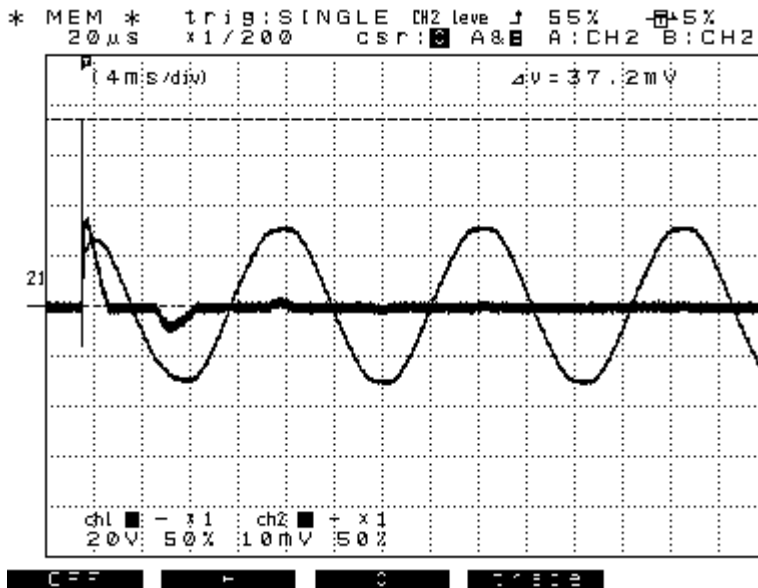

Wave No.2	
CH1	Measuring Point : Input Voltage
	Range 200V/DIV
CH2	Measuring Point : Input Current
	Range 20A/DIV
Time Line	5ms/DIV
Conditions	Input : AC240V 60Hz Load : Rated Load
Note :	
Inrush Current Value : 74.4A	

Model	PCS3-220P-X2S
Item	Dynamic Load Response

V1: +5V 6A

70% Load 100% Load

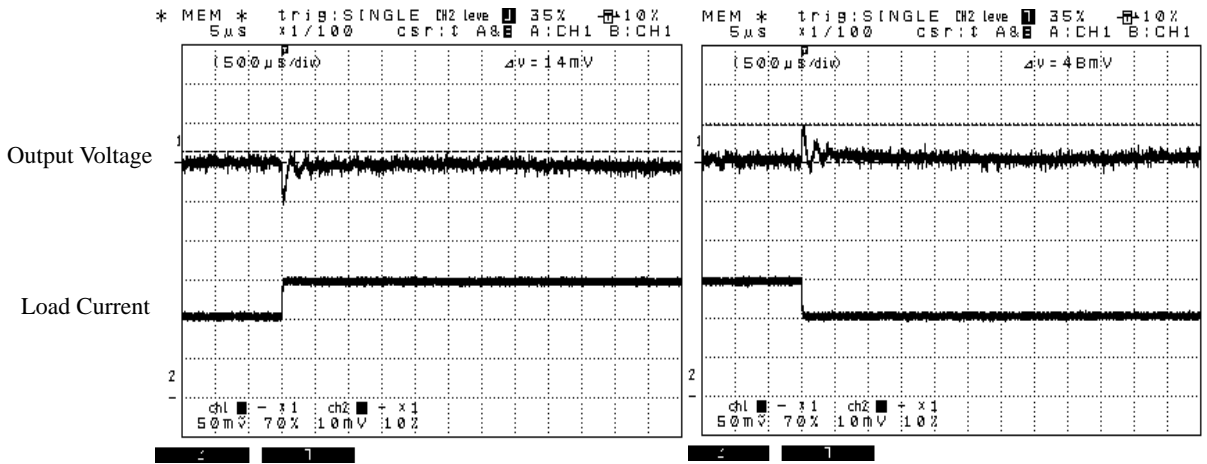

Sudden Fluctuation of Load	Fluctuation Value	ATX Specific Value	Judgment
70% Load 100% Load	14mV -56mV	± 250mV	Good
100% Load 70% Load	48mV - mV		Good

Model	PCS3-220P-X2S
Item	Dynamic Load Response

V2: +3.3V 10A

70% Load 100% Load

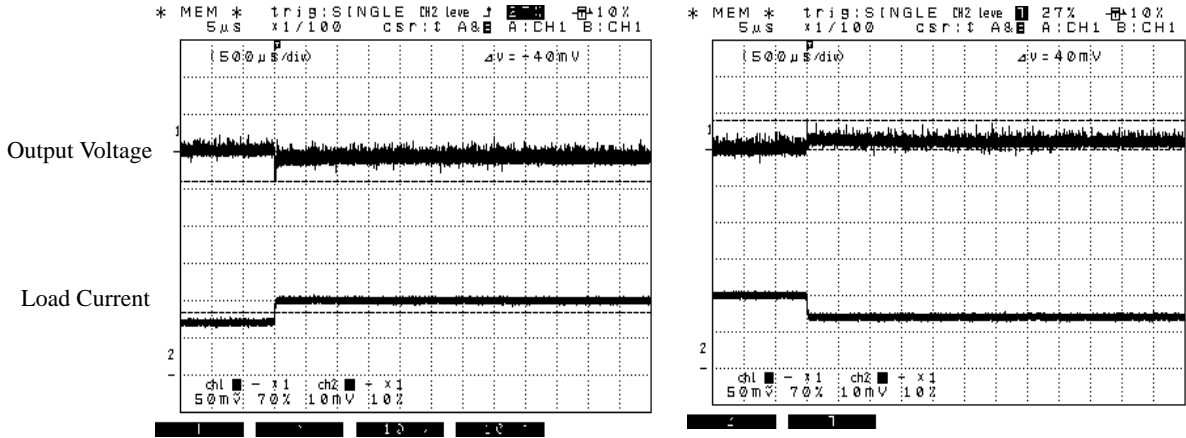

Sudden Fluctuation of Load	Fluctuation Value	ATX Specific Value	Judgment
70%Load 100% Load	- mV -40mV	± 165mV	Good
100% Load 70% Load	40mV - mV		Good

Model	PCS3-220P-X2S
Item	Dynamic Load Response

V3: +12V 10A

50% Load 100% Load

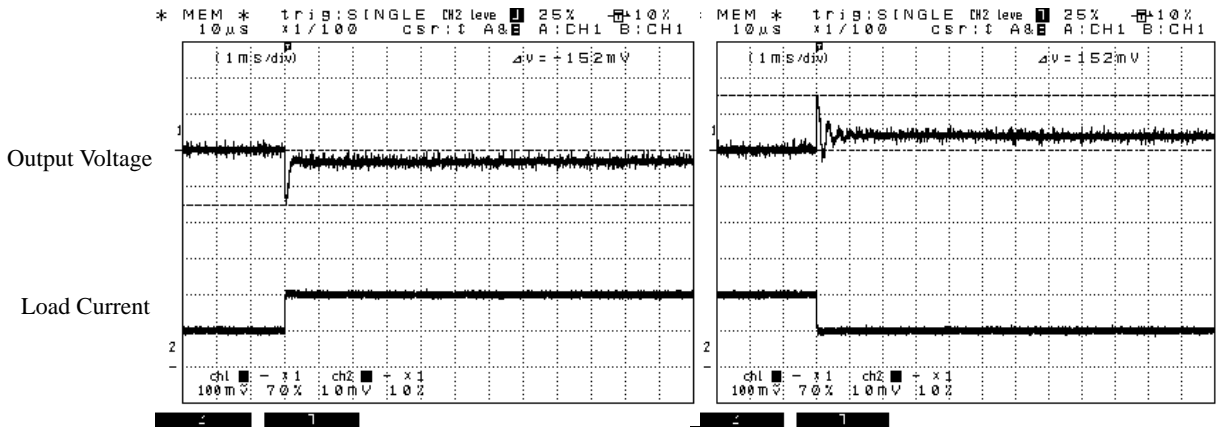

Sudden Fluctuation of Load	Fluctuation Value	ATX Specific Value	Judgment
50%Load 100% Load	- mV -152mV	± 600mV	Good
100% Load 50% Load	152mV -36mV		Good

Model	PCS3-220P-X2S
Item	12V Cross Regulation

12V Load Current [A]

12V Load Current	12V Voltage Value [V]			
	5V 1.5A	5V 3A	5V 6A	5V 15A
0A	12.201	12.202	12.196	12.203
2.5A	12.163	12.163	12.159	12.160
5A	12.158	12.157	12.154	12.153
7.5A	12.152	12.153	12.151	12.154
8A	12.149	12.151	12.149	12.153
10A	12.120	12.122	12.121	12.147
12A	12.083	12.086	12.093	-

12V Load Current	Fluctuation Value [%]			
	5V 1.5A	5V 3A	5V 6A	5V 15A
0A	1.68	1.68	1.63	1.69
2.5A	1.36	1.36	1.33	1.33
5A	1.32	1.31	1.28	1.28
7.5A	1.27	1.28	1.26	1.28
8A	1.24	1.26	1.24	1.28
10A	1.00	1.02	1.01	1.23
12A	0.69	0.72	0.77	-

Model	PCS3-220P-X2S			
Item	Ambient Temperature Drift			
V1:5V 6A				
at AC Input				
Output Voltage [V]				
Temperature ()	Input Voltage AC90V	Input Voltage AC100V	Input Voltage AC240V	Input Voltage AC264V
-5	5.002	5.002	5.002	5.002
25	4.998	4.998	4.998	4.998
45	4.989	4.989	4.989	4.989
55 ⁽¹⁾	4.997	4.997	4.997	4.997
60 ⁽²⁾	5.008	5.008	5.008	5.008
Fluctuation Value [%]				
Temperature ()	Input Voltage AC90V	Input Voltage AC100V	Input Voltage AC240V	Input Voltage AC264V
-5	0.04	0.04	0.04	0.04
25	-0.04	-0.04	-0.04	-0.04
45	-0.22	-0.22	-0.22	-0.22
55 ⁽¹⁾	-0.06	-0.06	-0.06	-0.06
60 ⁽²⁾	0.16	0.16	0.16	0.16
(1) 85% of Rated Load				
(2) 70% of Rated Load				
V2:3.3V 10A				
at AC Input				
Output Voltage [V]				
Temperature ()	Input Voltage AC90V	Input Voltage AC100V	Input Voltage AC240V	Input Voltage AC264V
-5	3.281	3.281	3.281	3.281
25	3.275	3.275	3.274	3.274
45	3.268	3.268	3.267	3.267
55 ⁽¹⁾	3.274	3.274	3.275	3.275
60 ⁽²⁾	3.283	3.283	3.283	3.283
Fluctuation Value [%]				
Temperature ()	Input Voltage AC90V	Input Voltage AC100V	Input Voltage AC240V	Input Voltage AC264V
-5	-0.58	-0.58	-0.58	-0.58
25	-0.76	-0.76	-0.79	-0.79
45	-0.97	-0.97	-1.00	-1.00
55 ⁽¹⁾	-0.79	-0.79	-0.76	-0.76
60 ⁽²⁾	-0.52	-0.52	-0.52	-0.52
(1) 85% of Rated Load				
(2) 70% of Rated Load				

Model	PCS3-220P-X2S			
Item	Ambient Temperature Drift			
V3: 12V 10A				
at AC Input				
Output Voltage [V]				
Temperature ()	Input Voltage AC90V	Input Voltage AC100V	Input Voltage AC240V	Input Voltage AC264V
-5	12.155	12.155	12.154	12.154
25	12.113	12.111	12.106	12.105
45	12.067	12.066	12.062	12.061
55 ⁽¹⁾	12.053	12.053	12.049	12.049
60 ⁽²⁾	12.047	12.047	12.044	12.044
Fluctuation Value [%]				
Temperature ()	Input Voltage AC90V	Input Voltage AC100V	Input Voltage AC240V	Input Voltage AC264V
-5	1.29	1.29	1.28	1.28
25	0.94	0.92	0.88	0.88
45	0.56	0.55	0.52	0.51
55 ⁽¹⁾	0.44	0.44	0.41	0.41
60 ⁽²⁾	0.39	0.39	0.37	0.37
(1) 85% of Rated Load				
(2) 70% of Rated Load				
V4: -12V 0.3A				
at AC Input				
Output Voltage [V]				
Temperature ()	Input Voltage AC90V	Input Voltage AC100V	Input Voltage AC240V	Input Voltage AC264V
-5	-12.159	-12.160	-12.161	-12.162
25	-12.172	-12.172	-12.172	-12.172
45	-12.184	-12.185	-12.185	-12.185
55 ⁽¹⁾	-12.184	-12.183	-12.183	-12.183
60 ⁽²⁾	-12.178	-12.178	-12.178	-12.178
Fluctuation Value [%]				
Temperature ()	Input Voltage AC90V	Input Voltage AC100V	Input Voltage AC240V	Input Voltage AC264V
-5	1.33	1.33	1.34	1.35
25	1.43	1.43	1.43	1.43
45	1.53	1.54	1.54	1.54
55 ⁽¹⁾	1.53	1.53	1.53	1.53
60 ⁽²⁾	1.48	1.48	1.48	1.48
(1) 85% of Rated Load				
(2) 70% of Rated Load				

Model	PCS3-220P-X2S			
Item	Ambient Temperature Drift			
V5: -5V 0.3A				
at AC Input				
Output Voltage [V]				
Temperature ()	Input Voltage AC90V	Input Voltage AC100V	Input Voltage AC240V	Input Voltage AC264V
-5	-4.952	-4.953	-4.954	-4.954
25	-4.959	-4.959	-4.959	-4.959
45	-4.966	-4.967	-4.967	-4.967
55 ⁽¹⁾	-4.964	-4.964	-4.964	-4.964
60 ⁽²⁾	-4.958	-4.958	-4.958	-4.958
Fluctuation Value [%]				
Temperature ()	Input Voltage AC90V	Input Voltage AC100V	Input Voltage AC240V	Input Voltage AC264V
-5	-0.96	-0.94	-0.92	-0.92
25	-0.82	-0.82	-0.82	-0.82
45	-0.68	-0.66	-0.66	-0.66
55 ⁽¹⁾	-0.72	-0.72	-0.72	-0.72
60 ⁽²⁾	-0.84	-0.84	-0.84	-0.84
(1) 85% of Rated Load				
(2) 70% of Rated Load				
V6: 5Vs 1.5A				
at AC Input				
Output Voltage [V]				
Temperature ()	Input Voltage AC90V	Input Voltage AC100V	Input Voltage AC240V	Input Voltage AC264V
-5	4.944	4.944	4.944	4.944
25	4.953	4.953	4.953	4.953
45	4.951	4.951	4.950	4.950
55 ⁽¹⁾	4.962	4.962	4.962	4.962
60 ⁽²⁾	4.980	4.980	4.980	4.980
Fluctuation Value [%]				
Temperature ()	Input Voltage AC90V	Input Voltage AC100V	Input Voltage AC240V	Input Voltage AC264V
-5	-1.12	-1.12	-1.12	-1.12
25	-0.94	-0.94	-0.94	-0.94
45	-0.98	-0.98	-1.00	-1.00
55 ⁽¹⁾	-0.76	-0.76	-0.76	-0.76
60 ⁽²⁾	-0.40	-0.40	-0.40	-0.40
(1) 85% of Rated Load				
(2) 70% of Rated Load				

Model	PCS3-220P-X2S
Item	Harmonic Current

Measuring Instrument : MP701(Keisoku Giken)

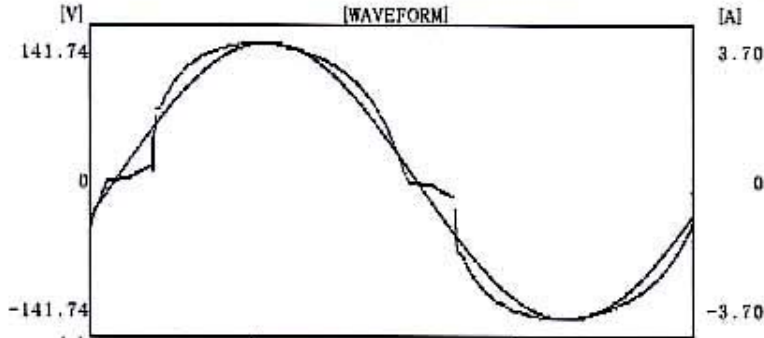

Vrms = 100.09 [V]
 Irms = 2.7769 [A]
 Ipeak = 3.6955 [A]
 WATT = 276.05 [W]
 VA = 277.93 [VA]
 Var = 32.28 [Var]
 PF = 0.9937
 Frq = 50.00 [Hz]

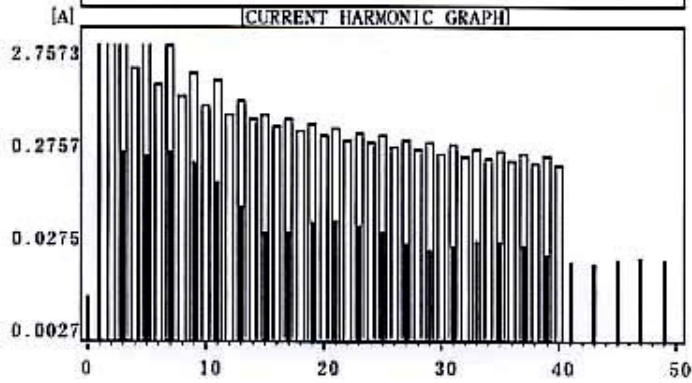

Std. : [Revised]
 IEC555-2 (S) 77A
 CLASS : A
 Rated Volt : 100V
 Judge Factor : 1.00
 Judgement : PASS

[CURRENT HARMONIC DATA]

No	(A)	No	(A)	No	(A)	No	(A)
00	0.0051	13	0.0411	26	0.0004	39	0.0133
01	2.7573	14	0.0011	27	0.0175	40	0.0002
02	0.0015	15	0.0227	28	0.0007	41	0.0116
03	0.1519	16	0.0007	29	0.0149	42	0.0009
04	0.0011	17	0.0234	30	0.0008	43	0.0108
05	0.1378	18	0.0007	31	0.0164	44	0.0007
06	0.0005	19	0.0291	32	0.0011	45	0.0120
07	0.1548	20	0.0009	33	0.0188	46	0.0002
08	0.0002	21	0.0304	34	0.0008	47	0.0128
09	0.1191	22	0.0011	35	0.0188	48	0.0008
10	0.0009	23	0.0279	36	0.0002	49	0.0123
11	0.0760	24	0.0007	37	0.0165		
12	0.0010	25	0.0227	38	0.0005		

Model	PCS3-220P-X2S
Item	Harmonic Current

Measuring Instrument : MP701(Keisoku Giken)

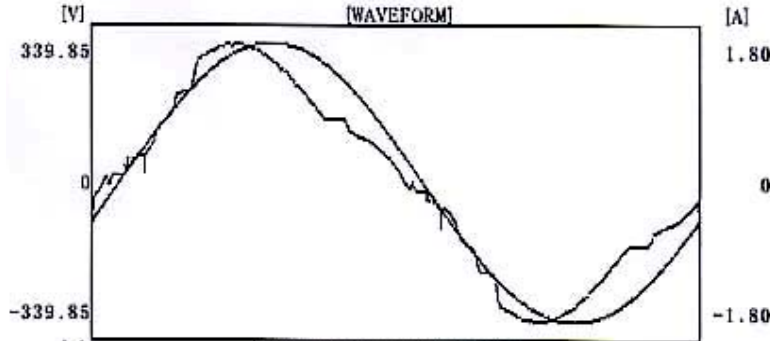

Vrms = 240.05 [V]
 Irms = 1.1223 [A]
 Ipeak = 1.8037 [A]
 WATT = 260.87 [W]
 VA = 269.40 [VA]
 Var = 67.27 [Var]
 PF = 0.9688
 Frq = 50.00 [Hz]

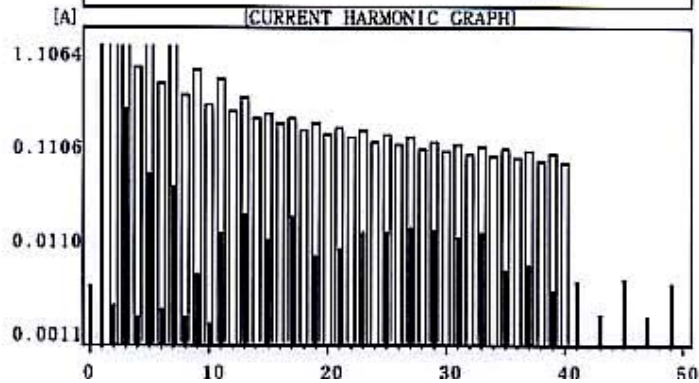

Std. : [Revised]
 IEC555-2 (S) 77A
 CLASS : A
 Rated Volt : 230V
 Judge Factor : 1.00
 Judgement : PASS

[CURRENT HARMONIC DATA]

No	{A}	No	{A}	No	{A}	No	{A}
00	0.0028	13	0.0150	26	0.0008	39	0.0025
01	1.1064	14	0.0009	27	0.0109	40	0.0005
02	0.0018	15	0.0085	28	0.0002	41	0.0030
03	0.1731	16	0.0004	29	0.0106	42	0.0004
04	0.0014	17	0.0141	30	0.0002	43	0.0014
05	0.0386	18	0.0006	31	0.0089	44	0.0006
06	0.0016	19	0.0056	32	0.0006	45	0.0033
07	0.0295	20	0.0004	33	0.0096	46	0.0003
08	0.0013	21	0.0066	34	0.0005	47	0.0013
09	0.0036	22	0.0008	35	0.0042	48	0.0005
10	0.0011	23	0.0098	36	0.0002	49	0.0030
11	0.0100	24	0.0007	37	0.0045		
12	0.0009	25	0.0099	38	0.0005		

Model	PCS3-220P-X2S
Item	Leakage Current Test

Temperature Room Temperature
 Input AC100V, 240V
 Load Rated Load , Minimum Load

Input Voltage (V)	at Rated Load (mA)	at Minimum Load (mA)
100V	0.25	0.21
240V	0.48	0.48

Measuring Instrument: YEW.TYPE3226 Applicable Products (Range: 1K)

Model	PCS3-220P-X2S
Item	Line Noise Tolerance

Temperature	Room Temperature
Input	AC100V,60Hz
Load	Rated Load
Noise Impressed Voltage	± 2000V
Repeat Cycle	10 ~ 35ms
Pulse Width	100,800ns

Normal	Pulse Impressed Mode			
	100ns		800ns	
	Polarity +	Polarity -	Polarity +	Polarity -
Common R Phase	Pulse Impressed Mode			
	100ns		800ns	
	Polarity +	Polarity -	Polarity +	Polarity -
Common S Phase	Pulse Impressed Mode			
	100ns		800ns	
	Polarity +	Polarity -	Polarity +	Polarity -

- No Trouble
- Faulty Operation of Over-Voltage and so on
- × Power Supply Breakdown

Measuring Instrument : INS420 (Noise Laboratory Co.,Ltd.)

Model	PCS3-220P-X2S
Item	Conduction Emission

Temperature	Room Temperature
Input	AC100V
Load	Rated Load
Measuring Point	L-FG
Measuring Instrument	R3261A (Advantest)

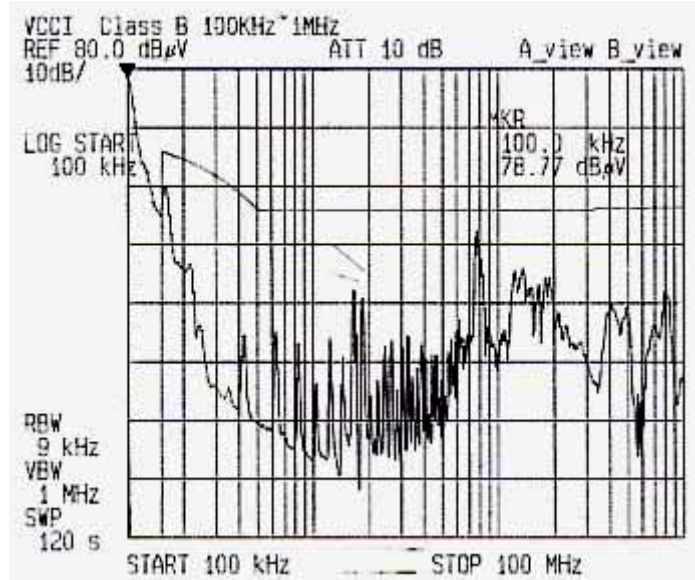

Model	PCS3-220P-X2J
Item	Conduction Emission

Temperature	Room Temperature
Input	AC240V
Load	Rated Load
Measuring Point	L-FG
Measuring Instrument	R3261A (Advantest)

