

This specification applies to Embedded type DC stabilized power supplies written below.  
 HN5P9-520P-S20-H0V-24V: Embedded type DC stabilized power supply with backup function at blackout  
 HN5P9-520P-S20-H1V-24V: HN5P9-520P-S20-H0V (24V) with dedicated RS232C signal unit, SU-RS.  
 HN5P9-520P-S20-H2V-24V: HN5P9-520P-S20-H0V (24V) with dedicated buzzer unit, SU-BU.  
 And HN5P9-520P-S20-H6V-24V: HN5P9-520P-S20-H0V (24V) with dedicated USB signal unit, SU-US2.

This unit provides DC output power with a dedicated battery pack (24 VDC) connected even at AC power failure.  
 Items marked with “\*1” in this specification apply to HN5P9-520P-S20-H1V-24V.  
 Items marked with “\*2” in this specification apply to HN5P9-520P-S20-H2V-24V.  
 Items marked with “\*3” in this specification apply to HN5P9-520P-S20-H6V-24V.

**General specification** (Provided at normal temperature and humidity unless otherwise specified)

Items		Specifications	Measurement conditions, etc.
AC Input	Rated voltage	100-240 VAC	Worldwide range
	Voltage range	85-264 VAC	(Note 1)
	Current	5.0A typical at 100 VAC / 2.1A typical at 240 VAC	
	Rated frequency	50 / 60 Hz	Frequency range: 47-63Hz
	Inrush current	31Apeak MAX at 100 VAC 75Apeak MAX at 240 VAC	(Note 2) with continuous rated output at cold start (25°C)
	Power factor	96% min. (100 VAC) / 90% min. (240 VAC)	
	Efficiency	80% typical at 100 VAC / 85% typical at 240 VAC	At rated output
DC Input	Nominal voltage	24 VDC (compatible with special battery pack)	
	Battery discharge cut-off voltage	17V typical (battery circuit cut-off)	
	Efficiency	80% typical	At nominal input and rated output power
Environment	Operating temp. /Humidity	0 to 60°C / 10 to 90% RH	Except battery pack No condensation (Note 3)
	Storage temp. /Humidity	-20 to 70°C / 10 to 95% RH	Except battery pack No condensation (Note 3)
	Vibration	To endure Vibration acceleration of 2G, Vibration of 10 to 55Hz for 10 sweep cycles in each X-, Y, and Z direction 10 times	JIS-C-60068-2-6 At no operation
	Mechanical strength	Lift one bottom edge 50mm high with the opposite edge placed on a test bench, and let it fall. Repeat 3 times on other three edges as well and no malfunction shall be observed	JIS-C-60068-2-31 At no operation

**Note**  
 Note 1. Load factor shall be 90 to 100% at 85-90 VAC. (Refer to output specification)  
 Note 2. Charging current equal to or less than 100µs into X-capacitor in input filter circuit shall not be defined as Inrush current.  
 Note 3. Follow the derating condition in another page when the ambient temperature exceeds 45°C.



Drawn by	Yodo	Reviewed by		Approved by		Series name:	HN5P9-520P-S20-H*V-24V	Drawing No.	3 1 4 3 - 0 1 - 4 - 5 2 3	1/10
----------	------	-------------	--	-------------	--	--------------	------------------------	-------------	---------------------------	------



Items		Specifications	Measurement conditions, etc.
Insulation	Insulation resistance	50MΩ or more between AC input and FG/output/DC input	At 500 VDC
	Dielectric strength	AC1.5kV for one minute between AC Input and FG/output/DC Input	Cut-off current 20mA
	Leakage current	0.5mA max. at 100 VAC input, 1.0mA max. at 200 VAC input, 1.2mA max. at 240 VAC Input	YEW.TYPE3226 (1kΩ range) or equivalent
EMS/EMI	Line noise immunity	±2,000V (pulse width of 100/1000ns, cycle period of 30 to 100Hz, Normal/Common mode with Positive/Negative polarity for 10 minutes)	To be measure with INS-410. There shall be no fluctuation in DC-component of output or no malfunction
	Surge immunity	IEC 61000-4-5 Installation Environment Class 3 compliant Common mode : ±2kV, Normal mode: ±1kV 5times for each	There shall be no malfunction or no failure At 100V/240V AC
	Electrostatic Discharge immunity	IEC 61000-4-2 test level 3 compliant Contact discharge:10 times at ±6kV	There shall be no malfunction or no failure At 100V/240V AC
	Conducted emission	VCCI / FCC / EN55022 Class A compliant	To be measured on the single power supply
	Harmonic current	IEC61000-3-2(Ed.2.1) Class D, EN61000-3-2(A14) Class D compliant	At rated input and load
Others	Safety standard	UL60950, CSA60950 (c-UL), CCC acquire, CE marking(IEC62368-1), PSE compliant 	Class I equipment: Embedded type power supply
	Cooling system	Forced air cooling by internal fan	Fan speed changes according to operating temp. and load condition (Note 1)
	Dimensions	150 (W)×85(H)×175(D)	Except protrusions; Refer to the outline drawing in another page
	Weight	2.2 kg	
	Reliability grade	FA	To follow our standard
	Lifetime expectancy	10 years or longer (Limited lifetime Component: Electrolytic capacitors and Fan motor)	Lifetime expectancy when operated at 100VAC, rated load, and 25 °C of the ambient temperature
	Warranty	Three years after delivery; If defects belong to us, the defective unit shall be repaired or replaced at our cost	Except the operation out of the specification

Note

Note 1. The fan speeds low only when the internal temperature of the power supply goes high while the power supply stops operation due to PS\_#ON signal.



A:  ×1 Oct.2nd 2020 UCHIDA

Drawn by	Yodo	Reviewed by		Approved by		Series name:	HNSP9-520P-S20-H*V-24V	Drawing No.	3 1 4 3 - 0 1 - 4 - 5 2 3 A 2/10
----------	------	-------------	---	-------------	---	--------------	------------------------	-------------	-------------------------------------

Output specification (All items shall be provided at normal temperature and humidity unless otherwise specified)										
Items		CH1	CH2	CH3	CH4	CH5 (5VSB)	CH6	Measurement conditions, etc.		
Output rating	Rated voltage	3.3V	5V	12V	-12V	5V	24V			
	Min. current	0A	0A	0A	0A	0A	0A			
	Rating	Rated current	7A	7A	17A	0.5A	2.0A	5A	Standard Value at measuring of input/output characteristics	
		Rated power	23.1W	35W	204W	6W	10W	120W		
	Continuous max	Max. current	20A	24A	25A	0.5A	2.0A	8.3A	Continuous rating. Maximum total output power is 400W (See the derating conditions on P.7)	
		Max. power	150W		300W	6W	10W	199.2W		
			300W							400W
	Peak rating	Peak current	30A	30A	35A	0.5A	2.5A	12.5A	Momentary rating is within 5 seconds. Momentary total output power is 520W (See Figure.1 and the derating conditions on P.7)	
		Peak power	200W		420W	6W	12.5W	300W		
			507.5W							520W
Output characteristics	Total voltage regulation	± 5%	± 5%	± 5%	± 5%	± 5%	± 5%	See the derating conditions on P.7		
	Max. ripple voltage (mV <sub>p-p</sub> )	50 Max.	50 Max.	120 Max.	120 Max.	50 Max.	160 Max.	Connect lead wires to output connector, and then measure on the test board with an electrolytic capacitor (47μF) and a ceramic capacitor (0.1μF)		
	Max. spike voltage (mV <sub>p-p</sub> )	100 Max.	100 Max.	170 Max.	170 Max.	100 Max.	200 Max.			
Protection	OCP	OCP point (A)	27 Min.	31 Min.	37 Min.	Short circuit protection		13 Min.	CH1: CH2 continuous max., others without loads CH2: CH1 continuous max., others without loads Others: all CH is measured with rated loads CH6: others without loads.	
		Method	All outputs except CH5 shut down. All outputs shut down at backup operation.			Hold-down current limiting	All outputs shut down	CH6 only Shuts off		
		Recovery	At AC operation	Reclosing of AC input or, PS_ON# signal "H" to "L".			Automatic recovery			Reclosing of AC input
	At battery operation		Reclosing of AC input			Automatic recovery	Reclosing of AC input	Reclosing of AC input		
	OVP	OVP point (V)	3.76 to 4.3	5.74 to 7.0	13.4 to 15.6	-	-	28.8 to 33.6		
		Method	All outputs except CH5 shut down. All outputs shut down at backup operation.			-	-	CH6 only Shuts off		
		Recovery	At AC operation	Reclosing of AC input or, PS_ON# signal "H" to "L"			-	-	Reclosing of AC input	
			At battery operation	Reclosing of AC input			-	-	Reclosing of AC input	
	Charging function	With a special Ni-MH battery pack connected	Charge voltage	35V max. (The voltage is automatically switched to correspond to the special Ni-MH battery pack)						
			Charge current	0.7A max. (Micro computer is installed inside the special battery pack to control charge current)						
With a special Lead-acid battery pack connected		Charge voltage	27.3V typical at full charge and 25°C, but to be compensated according to temperature							
		Charge current	0.5±0.2A (at 24V of battery voltage)							
Insulation between GNDs of each Output		GNDs of CH1 to CH5 and DC input are connected, GND of CH6 is separate.								

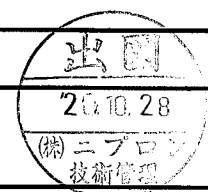

Drawn by	Yodo	Reviewed by		Approved by		Series name:	HNSP9-520P-S20-H*V-24V	Drawing No.	3 1 4 3 - 0 1 - 4 - 5 2 3
3/10									

Figure 1. Duty ratio of Peak current/Power

Peak current/Power shall be 5 seconds max. and its duty ratio shall be 10% max.

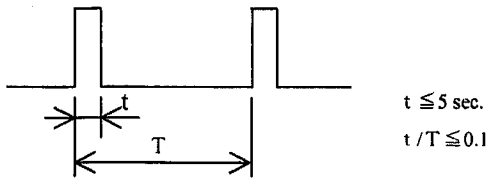
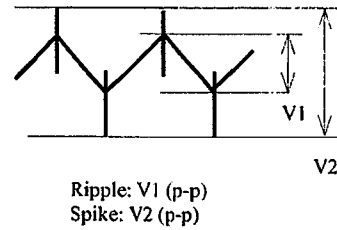

Figure2. The definition of ripple and spike



**Input/Output signal specification**

(Terms shall be provided at normal temperature and humidity unless otherwise specified)



Input signal	Output ON/OFF control signal (PS_ON#)	CH1 to CH4 and CH6 shut down at 'H' or 'OPEN' input (Battery connection shuts off when 'H' or 'OPEN' is received at backup operation)
	24V Output ON/OFF control signal (24V_ON)	24V outputs when it is shunt between 24V_ON+ and 24V_ON- short24V. (*Connectors are shorted at the shipment.) Invalid when PS_ON signal is 'H' or 'OPEN. (24V shutoff)
	+3.3V SENSE	Input terminal for voltage detection of CH1 (+3.3V); voltage drop of +side output cable is compensated when connected to load end
	Battery shutdown signal for TTL (SHUT_DOWN_T)	Battery connection shuts off at 'L' input with 60ms or longer (valid only at battery backup operation)
	(*1) Battery shutdown signal for RS232C (SHUT_DOWN_R)	Battery connection shuts off at 'positive 2.4V or higher input with 60ms or longer (valid only at battery backup operation)
	Fan control signal (FAN_C)	Control terminal of a fan motor Fan motor operates at a maximum speed upon receipt of ' L '
Output signal	Normal output signal (PWR_OK)	'H' is delivered at normal output (Detection delay time: 100 to 500ms)
	AC failure detection signal for TTL (AC_FAIL_T)	'H' is delivered at low AC input voltage or power failure (Detection voltage: AC 75V typical, Detection delay time: 16 to 40ms after power failure) (Note 1)
	(*1) AC failure detection signal for RS232C (AC_FAIL_R)	'-9V typical' is delivered at low AC input or power failure detection (Detection voltage: AC 75V typical, Detection delay time: 16 to 40ms after power failure) (Note 1)
	(*3) AC failure detection signal for USB (AC_FAIL_U)	Data signal equivalent to 'Negative' of AC_FAIL_R signal is delivered at low AC input or power failure detection (Detection voltage: AC 75V typical, Detection delay time: 16 to 40ms after power failure) (Note 1)
	Low battery voltage signal for TTL (BATT_LOW_T)	'H' is delivered when battery terminal voltage is too low (≤19V typ.) ('L' is delivered when battery pack is not connected)
	(*1) Low battery voltage signal for RS232C (BATT_LOW_R)	'-9V typical' is delivered when battery voltage falls down to 19V typical ('+9V typical' is delivered when battery pack is not connected)
	(*3) Low battery voltage signal for USB (BATT_LOW_U)	Data signal equivalent to 'Negative' of BATT_LOW_R signal is delivered when battery voltage falls down to 19V typical (Data signal equivalent to 'Positive' of BATT_LOW_R signal is delivered when battery pack is not connected)
	(*2) Buzzer sound	Buzzer goes off at power failure (Sound level is adjustable by a variable resistor) (Note) Buzzer may go off for several seconds at AC power-on and AC power-off
	Fan monitoring signal (FAN_M)	Two pulses per rotation of individual motors are delivered.



Note

Note1. At rated input/output

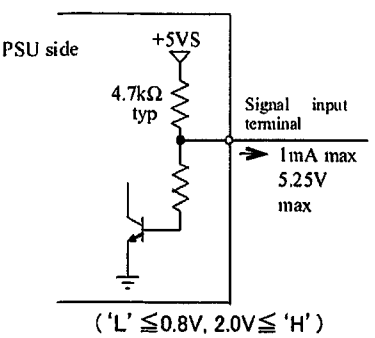
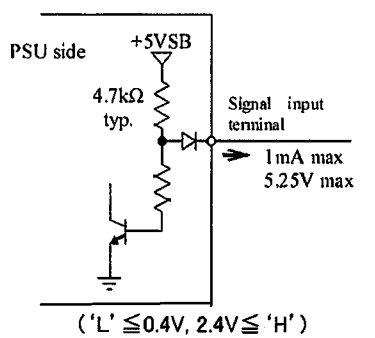
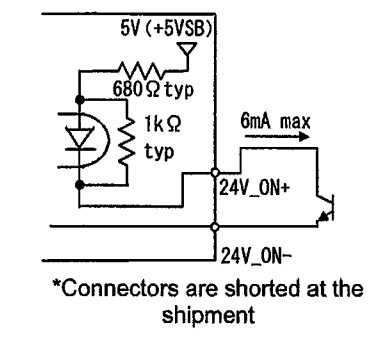
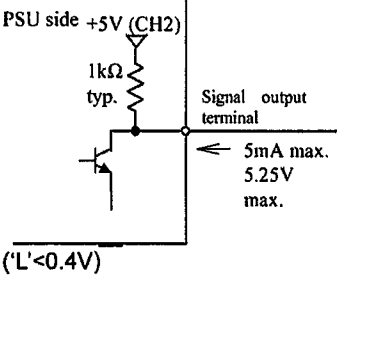
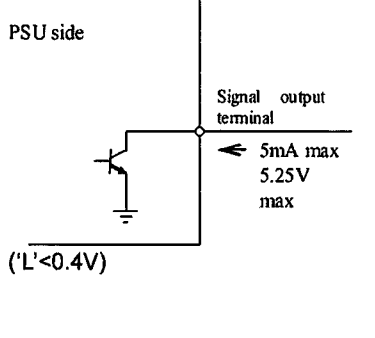

Drawn by	Yodo	Reviewed by		Approved by		Series name: HNSP9-520P-S20-H*V-24V	Drawing No. 3 1 4 3 - 0 1 - 4 - 5 2 3
							4/10

Input signal circuit	<p>PS_ON</p>  <p>(<math>'L' \leq 0.8V, 2.0V \leq 'H'</math>)</p>	<p>SHUT DOWN_T</p>  <p>(<math>'L' \leq 0.4V, 2.4V \leq 'H'</math>)</p>	(*1) SHUT DOWN_R	ADM232AARN (Analog devices) or equivalent		
	<p>24V_ON</p>  <p>*Connectors are shorted at the shipment</p>					
Output signal circuit	<p>PWR_OK</p>  <p>(<math>'L' &lt; 0.4V</math>)</p>	<p>AC FAIL_T, FAN_M, BATT LOW_T</p>  <p>(<math>'L' &lt; 0.4V</math>)</p>	(*1) AC FAIL_R BATT LOW_R	(*3) AC FAIL_U BATT LOW_U	ADM232AARN (Analog devices) or equivalent	USB1.1 compliant (B type connector) *Special driver software is required (Software such as UPS service that uses current RS232C signal can be run with USB signal)
	<p>Note:</p> <div style="text-align: right;">  </div>					

Drawn by	Yodo	Reviewed by		Approved by		Series name:	HNSP9-520P-S20-H*V-24V	Drawing No.	3143-01-4-523	5/10
----------	------	-------------	---	-------------	---	--------------	------------------------	-------------	---------------	------

Input/Output signal specification (All items shall be provided at normal temperature and humidity unless otherwise specified)

Signal input/output timing diagram (With RS232 signal unit 'SU-RS', and a specified battery pack)

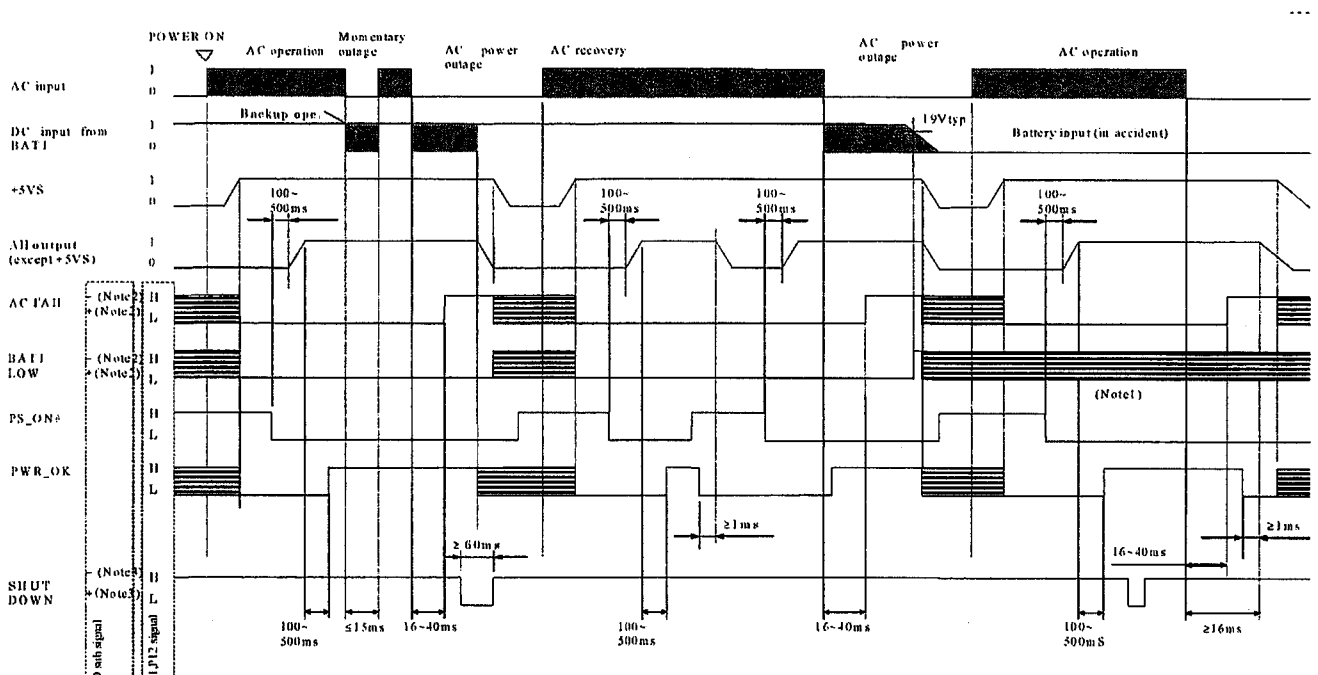

(Note 1) BATT LOW signal may not be outputted depending on the battery voltage because of battery charger output.  
 (Note 2) Negative (-) signal output: -9V typ. Positive (+) signal output: +9V typ.  
 (Note 3) Negative (-) signal output: +0.4V to -20V Positive (+) signal output: +2.8V to +20V  
 Indefinable area

Note: When auto shutdown is performed in Windows 2000/XP environment, do not use the shutdown signal. Use the Remote OFF control signal supported by APM or ACPI function after OS ends.



Drawn by	Yodo	Reviewed by	川政	Approved by	松原	Series name:	Drawing No.
						HN5P9-520P-S20-H*V-24V	3143-01-4-523
							6/10

**Installation condition**

1. This power supply unit should be installed with the clearance as shown below from the wall to its air inlet and outlet.
2. Temperature around the air inlet area of the power supply unit should not exceed the maximum operating temperature.

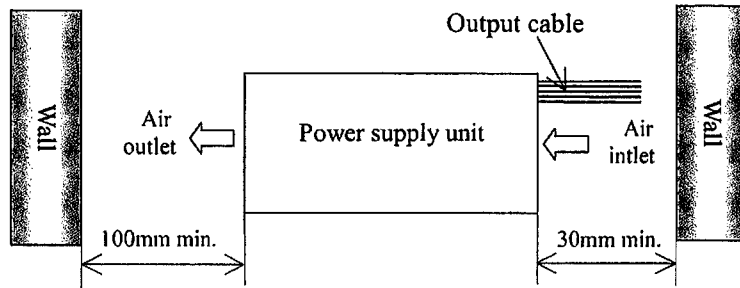

**Derating Conditions**

Follow the item 1 and 2 below to derate output current and power in operation at high temperature and low input voltage. For Continuous and Peak rating, max. output current of each CH specified in output specification shall be regarded as 100% of load factor. Also, when total power between channels is provided, total of those powers shall be regarded as 100% of load factor.

1. When the ambient temperature adjacent to the air inlet exceeds 45°C, follow the load factor shown in Fig.3 for continuous and peak rating.
2. When input voltage is 90V or less at operation of continuous rating and peak rating (5 sec max.), follow the load factor shown in Fig.4. In addition, when the ambient temperature exceeds 45°C, the load factor shall be the load factor shown in Fig 4 multiplied by the load factor shown in Fig.3.

**Cross regulation**

The total voltage regulation of CH2 (5V) and CH3 (12V) is defined by the combinatorial range shown in Fig.5 Cross regulation. It should be used within the combinatorial power between each CH.

Figure3. Derating curve for temperature

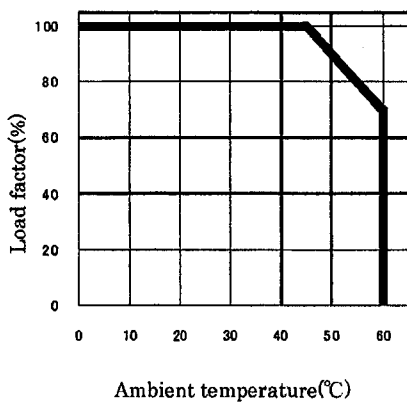

Figure4. Derating curve for low input voltage

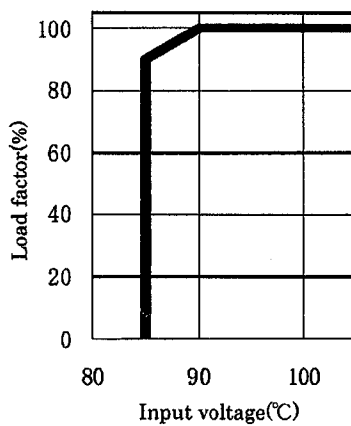
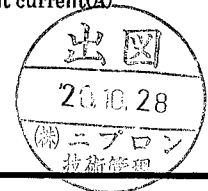
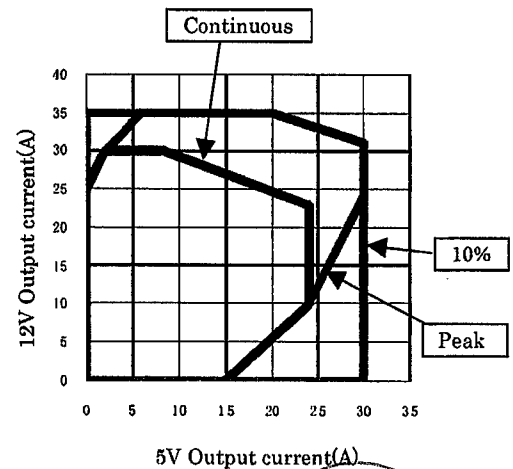

Figure5. Cross regulation



Drawn by	Yodo	Reviewed by	川政	Approved by	松原	Series name: HNSP9-520P-S20-H*V-24V	Drawing No. 3143-01-4-523
							- 7/10



**Current ratings of output connector pins**

The maximum allowable continuous current for each of output connector pins is shown in Table below.

The sum of the shared currents for the same output must be less than the maximum current specified for each output.

Connector	Pin	Output	Max. current	Note	
MAIN1 (Output 1)	1	+3.3V	6.0A		
	2	+3.3V SE	-	+3.3V Sensing input	
	3	+12V	6.0A		
	4	+5V	6.0A		
	5	+5V	6.0A		
	6	COM	6.0A		
	7	COM	6.0A		
	8	COM	6.0A		
	9	COM	6.0A		
	10	-12V	0.6A		
	11	+5VSB	4.0A		
	12	+3.3V	6.0A		
	13	+3.3V	6.0A		
	14	+12V	6.0A		
	15	+5V	6.0A		
	16	+5V	6.0A		
	17	COM	6.0A		
	18	COM	6.0A		
	19	COM	6.0A		
	20	COM	6.0A		
		21	PWR_OK	-	Signal output
		22	PS_ON	-	Signal input
MAIN2 (Output 2)	1	+5V	6.0A		
	2	+3.3V	6.0A		
12V1-2 (Output 3-4)	1	COM	6.0A		
	2	COM	6.0A		
	3	COM	6.0A		
	4	COM	6.0A		
	5	+12V	6.0A		
	6	+12V	6.0A		
	7	+12V	6.0A		
	8	+12V	6.0A		
HD (Output 5)	1	+3.3V	6.0A		
	2	+5V	6.0A		
	3	COM	6.0A		
	4	COM	6.0A		
	5	+12V	6.0A		
	6	+3.3V	6.0A		
	7	+5V	6.0A		
	8	COM	6.0A		
	9	COM	6.0A		
	10	+12V	6.0A		



Drawn by	Yodo	Reviewed by		Approved by		Series name: HN5P9-520P-S20-H*V-24V	Drawing No. 3 1 4 3 - 0 1 - 4 - 5 2 3
----------	------	-------------	---	-------------	---	--	--



Connector	Pin	Output	Max. current	Note
SIG (Output 6)	1	AC_FAIL	5mA	
	2	SHUT_DOWN	1mA	
	3	BAT_LOW	5mA	
	4	FAN_C	-	
	5	FAN_M	5mA	
	6	PS_ON	5mA	
	7	COM	2.0A	
	8	+3.3V SE	-	
	9	NC	-	
	10	+5VSB	2.0A	
24V-1 (Output 7)	1	+24V	7A	
	2	+24V	7A	
	3	COM (24V)	7A	
	4	COM (24V)	7A	
SIG (Output 8)	1	24V_ON+	6mA	
	2	24V_ON-	6mA	

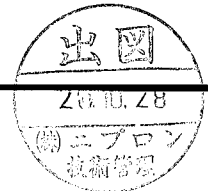



Drawn by	Yodo	Reviewed by		Approved by		Series name: HNSP9-520P-S20-H*V-24V	Drawing No. <b>3 1 4 3 - 0 1 - 4 - 5 2 3</b>
							9/10

Nipron co., Ltd.

**Warnings and Cautions on operation**

1. **WARNING:** ⚠ Grounding  
This power supply is designed as safety class I apparatus. For operator safety, be sure to ground the power supply by connecting the Earth terminal to earth ground.
2. **WARNING:** ⚠ Electrical shock hazards  
This power supply is designed for integrating. High potentials exist inside the power supply. When integrating the power supply into an instrument or system, use appropriate safe procedure to avoid electrical shock hazards.
3. **CAUTION:** ⚠ Output shortage  
Do not get output terminals shorted. When shorted, internal capacitors discharge at once to cause serious accident due to spark, etc. resulting in shortening lifetime of this unit.
4. **CAUTION:** ⚠ Inrush current limiting circuit  
Power thermistor is used to limit surge current to smoothing capacitors when AC input is turned on. When AC input is turned on shortly after AC input is turned off, excess surge current may flow as the power thermistor is still hot Make sure to turn on AC input 60 seconds or longer after AC input is turned off.
5. **Acoustic noise at power-on**  
Low frequency acoustic noise may be heard at turn-on of input or power-on by REMOTE ON/OFF signal. This noise is caused by low frequency transient vibration of choke coils for harmonic measures. This will not affect performance or lifetime at all.
6. **Output cable handling**  
Do not grab only output cables to move or carry this unit. Make sure to hold the main body while moving or carrying.



Drawn by	Yodo	Reviewed by		Approved by		Series name: HNSP9-520P-S20-H*V-24V	Drawing No. <b>3 1 4 3 - 0 1 - 4 - 5 2 3</b>
							10/10

Nipron co., Ltd.

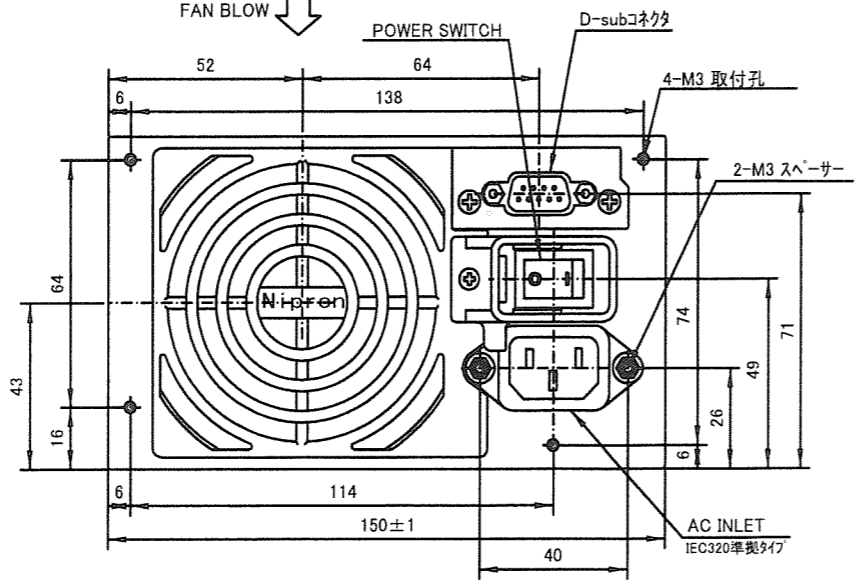
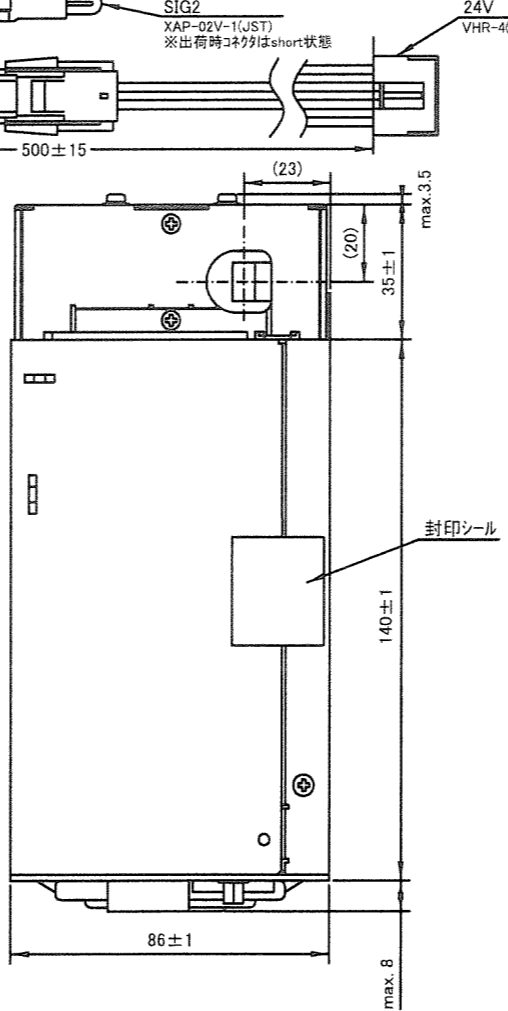
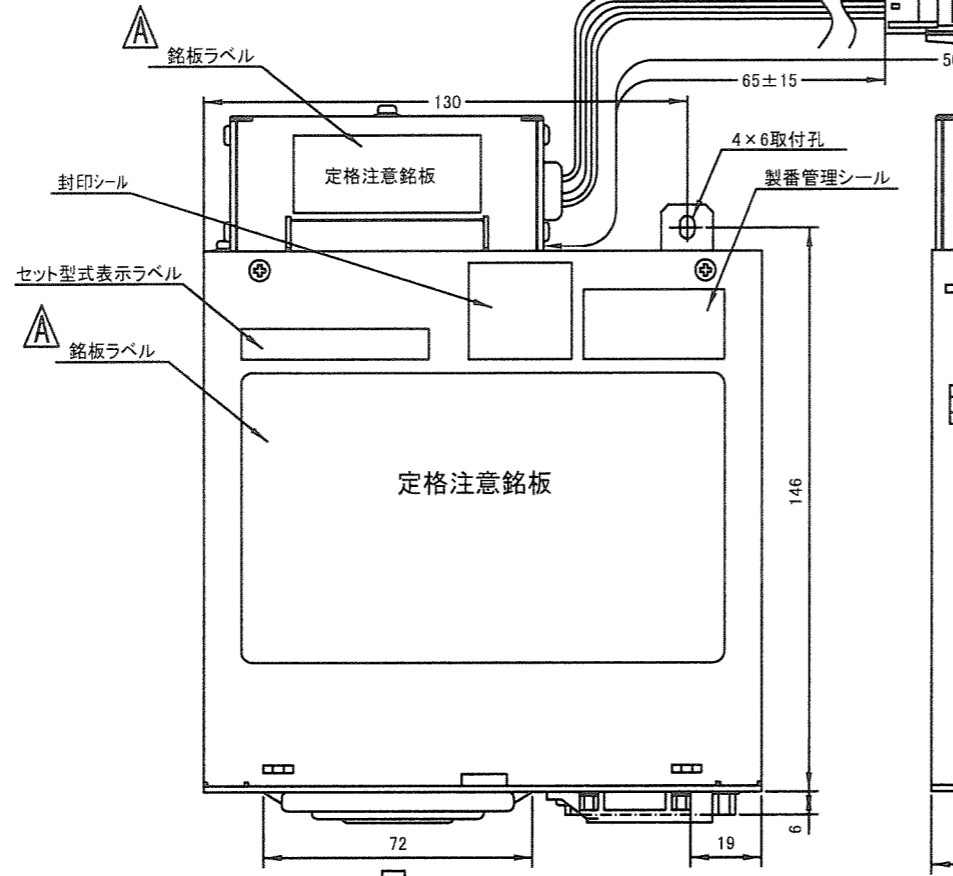
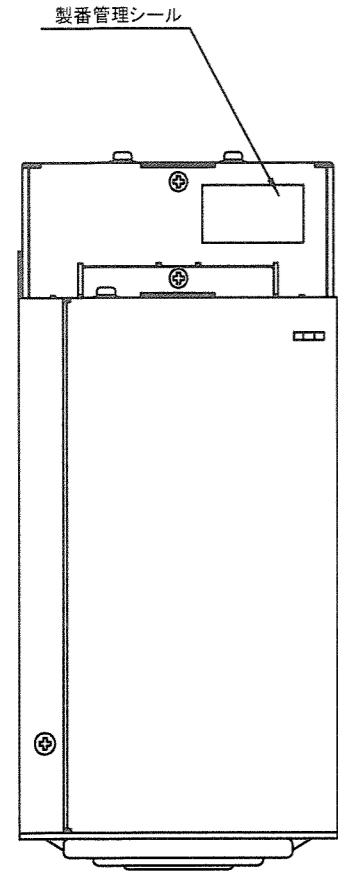
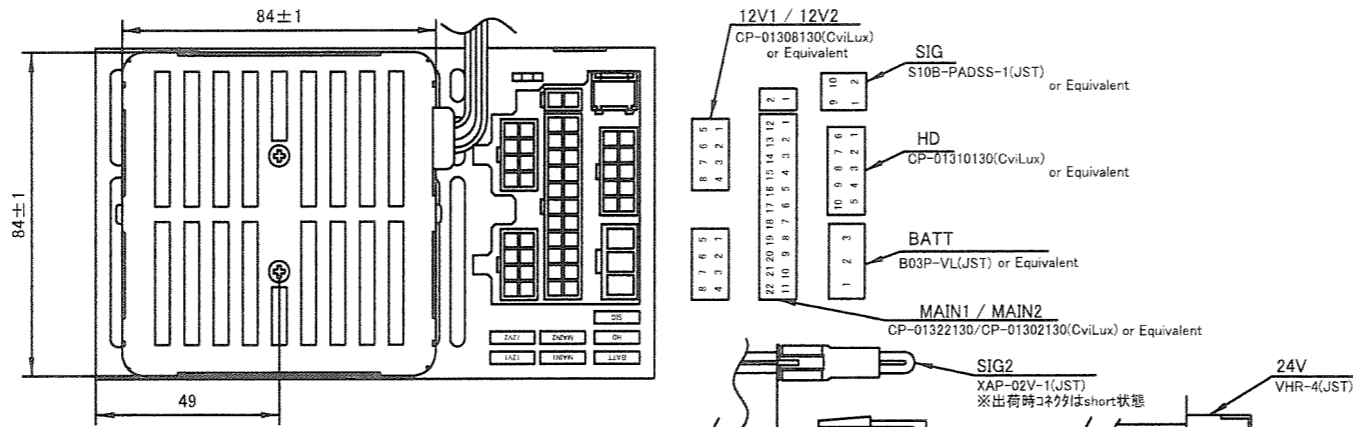

推奨電源取り付け穴加工図

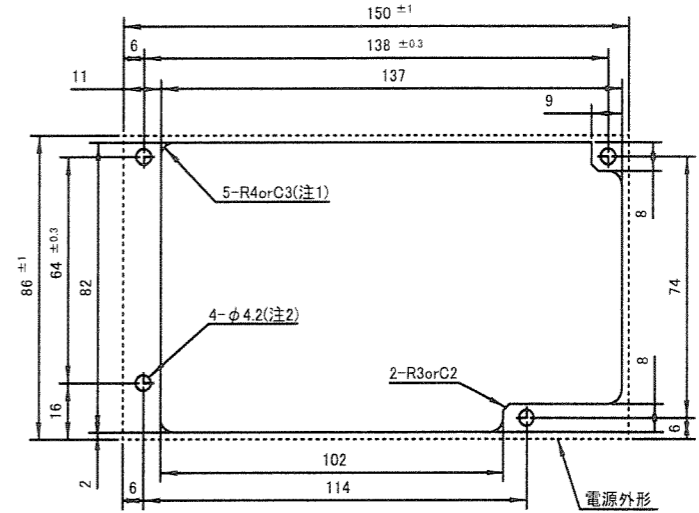

注1: R4 or C3 の値は小さくても可  
注2: 取付用ねじ穴

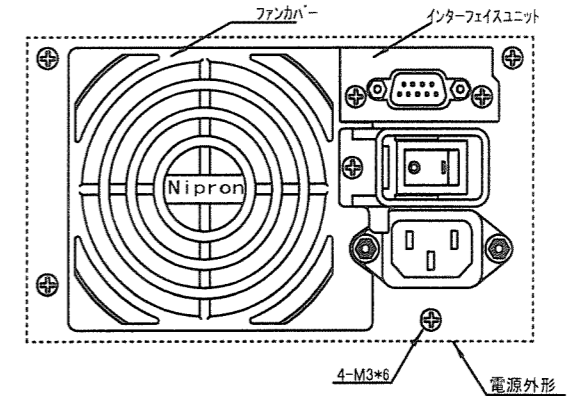

電源をパソコン等のキョウ体に取り付けた状態で  
ファン交換を行う場合は指定の穴加工を施して下さい。

- \* 取付ビスの電源ケース表面よりの内部侵入深さ Max.12 mm
- \* 指示なき寸法公差は ±0.5 とする

A版 : ×2 2013.02.19 奥平(直) I-250301 (銘板ラベル追加)

DRAWN BY	CHECKED BY	CHECKED BY	APPROVED BY	SCALE		MATERIALS	HN5P9-520P-S20-H1V-24V	
黒田				UNITS		m/m		TITLE
ISSUED	2012.03.30			3RD ANGLE PROJECTION		FINISH	DRAWING NO.	
							3185-01-3-050	A