

2022 May

Desktop PC Power Supply HN5P5-350P series



ATX Power Supply
CONTINUOUS MAX.: 245 W
PEAK POWER: 346 W

ATX power supply with a built-in lithium-ion battery

HNSP5-350P series

Continuous: **245.4W** Peak: **346W**

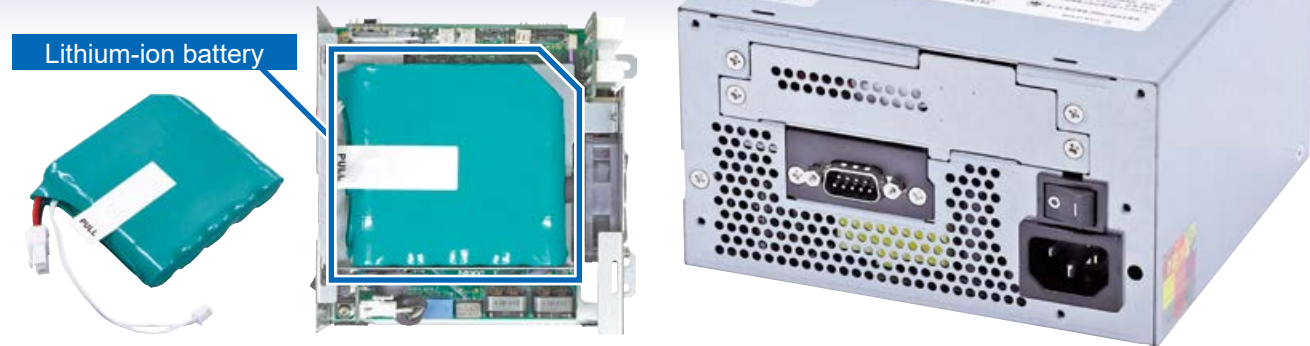

More space can be saved because of the battery pack in a housing

More space can be saved compared to commonly found UPS because of the battery pack in the housing. It is also possible to implement UPS function by replacing the existing ATX power supply with HNSP5-350P.

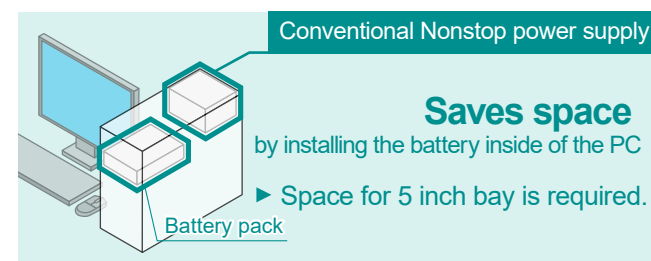
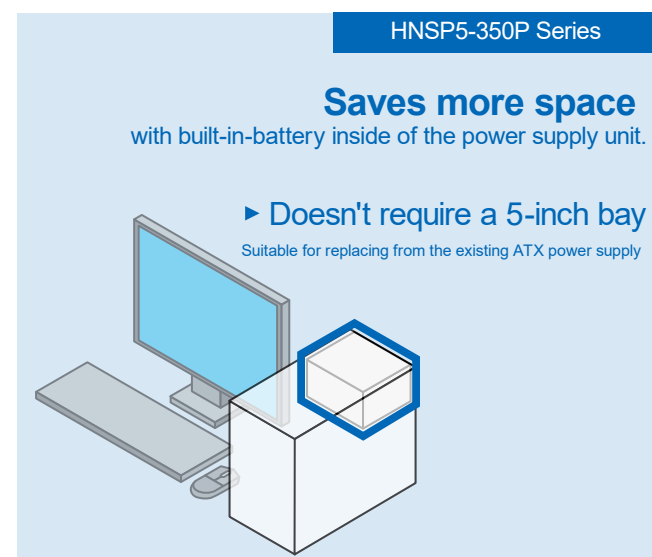
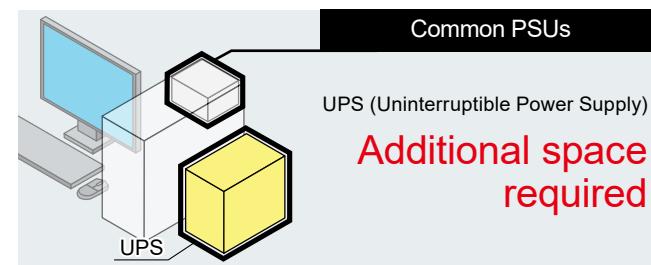

Smooth battery replacement is possible

The battery pack supports the replacement from the mounting surface of the power supply unit, making it unnecessary to disassemble the PC or removing the power supply unit from the housing.



Specifications

Output voltage	+3.3V	+5V	+12V	-12V	+5VSB
Max. current/power (continuous)	12A	12A	20A	0.5A	1A
	Total 66.4W		240W	6W	5W
	Total 240.4W				
Peak current/power (within 5s)	22A	22A	28A	0.5A	2A
	Total 113W		336W	6W	10W
	Total 346W				
Min. load current	0A	0A	0A	0A	0A

Lithium-ion battery for long time backup

While the power is normally supplied through the AC power grid, if there is a drop in the AC input voltage or a blackout, the backup power kicks in safely by switching to the built-in battery without any interruption.

Discharge time (The value shown is an example measurement not guaranteed.)

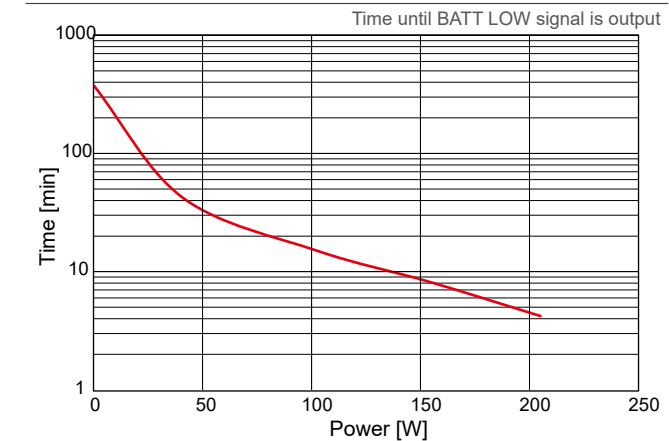

Charge time (The value shown is an example measurement not guaranteed.)

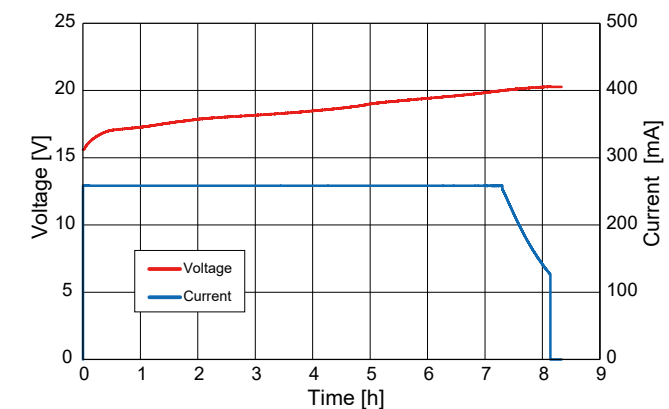

1. The battery is charged only while the PS_ON signal 'L' is input.
2. It is not charged when the battery temperature is below 10°C or above 50°C.
3. Discharge at an ambient temperature between 0°C and 50°C.

High quality and highly-reliable manufacturing

The power supply is designed with an optimum component layout, and produced in Japan. Also, in order to satisfy a variety of requirements for the power supply units from customers around the world, product evaluation tests are conducted thoroughly to find weaknesses. High reliability is achieved to enable long-term severe 24/7 operation at the rated power.

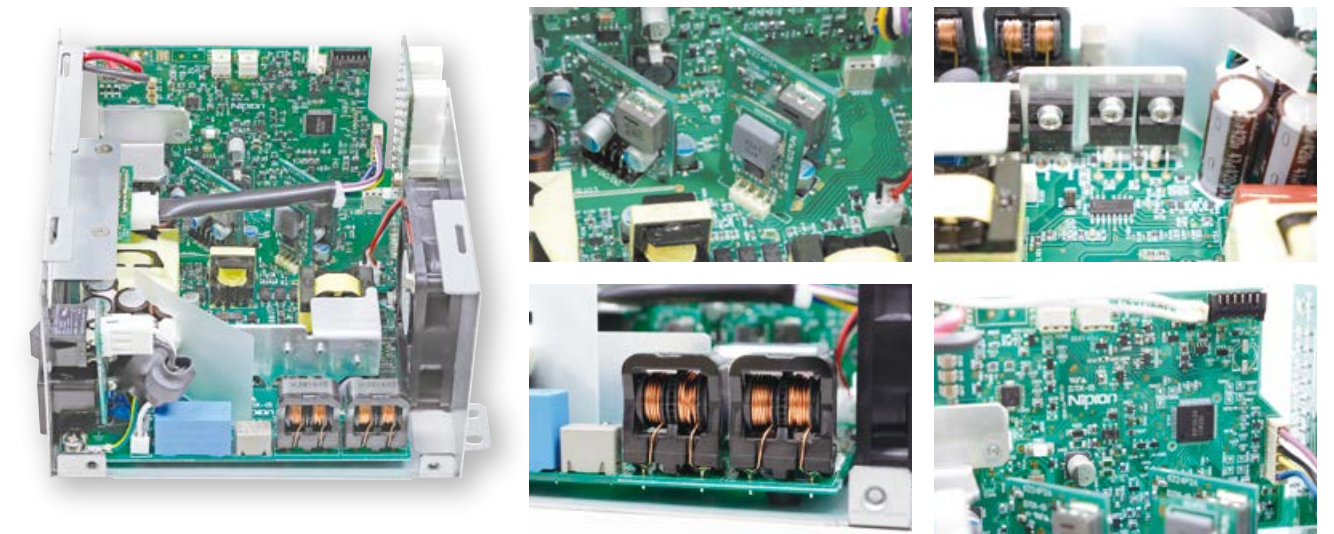

Low noise

With the enhancement of noise filter circuits and optimization of component arrangement, the power supply unit clears VCCI Class B for conducted emissions. No need for an external noise filter, helping to save associated work and costs.

Conducted emission characteristics

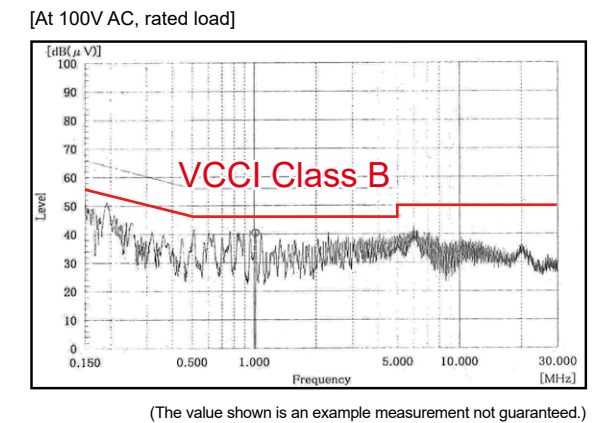

Other features

- Shutdown control signal from RS232C/USB
- Safe design which prevents screws from falling inside the power supply during battery replacement.
- Minimum load current 0A for all outputs
- Low sound noise by adopting a temperature controlled variable speed fan.

Desktop PC Power Supply HN5P5-350P Series

ATX power supply with built-in Li-ion battery No external battery required!



HN5P5-350P-S20-B1V

**RoHS
Directive**

ATX
Continuous **245.4W** Peak **346W**

Model	Description
HN5P5-350P-S20-B1V	With RS232C signal unit
HN5P5-350P-S20-B6V (Under development)	With USB signal unit

Model Name Coding
HN5P5-350P-S20-B*V

① Series name	④ Standard	⑧ Signal unit
② Output power	⑤ DC input voltage (battery voltage) 24V	⑨ Low sound noise
③ Peak power available	⑥ Modification	(Equipped with thermal-sensing variable speed fan)
⑦ Built-in Non-stop circuit		

Features

- More space can be saved because of the battery pack in a housing
- Double-sided PCB with plated through hole suitable for industrial use.
- Achieved low noise and low leakage current
- Min. load current is 0A for all outputs.
- By building in the thermal-sensing variable speed fan, noise reduction can be realised.
- Signal for shutdown control supports RS232C, and USB type will be available.

Dimension

W×H×D (mm)	150×85×140
------------	------------

Output connector (cables sold separately)

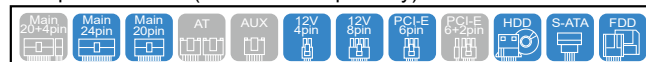

Safety standard	UL	CSA	EN	CE	CCC
Reliability grade	HFA	FA	HOA	OA	

Function

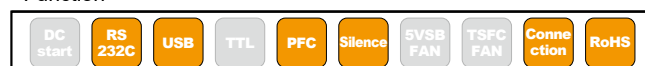

Input

AC input	85-264V AC (Worldwide range, with PFC)
----------	--

Output

Output voltage	+3.3V	+5V	+12V	-12V	+5VSB
Max. current/ max. power (continuous)	12A Total 66.4W	12A 240W	20A 6W	0.5A 5W	1A 5W
Peak current/ peak power (within 5s)	22A Total 113W	22A 336W	28A 6W	0.5A 10W	2A 10W
Max. current/ max. power (continuous) at backup	12A Total 66.4W	12A 192W	16A 6W	0.5A 10W	2A 10W
Min. current	0A	0A	0A	0A	0A

General Specification (Items are provided at normal temperature and humidity unless otherwise specified.)

Items	Specification	Measurements conditions, etc.	
AC Input	Rated Voltage	100-240VAC (85~264VAC)	Worldwide range *See <Fig.1> Low input voltage derating.
	Input Frequency	50/60Hz	Frequency range 47-63Hz
	Efficiency	84% typ (100VAC), 88% typ (240VAC) *Characteristic data: Fig.4	At rated output
	Power Factor	96% min. (100VAC), 90% min. (240VAC) *Characteristic data: Fig.5	
	Inrush Current *1	50A peak (100VAC), 100A peak (240VAC) *Characteristic data: Fig.6	At rated output, cold start (25°C) Reclosing interval of 60 s or longer
	Input Current	2.9A typ (100VAC), 1.2A typ (240VAC) *Characteristic data: Fig.4	Rated output when charging
Battery	Rated Voltage	18V	Lithium-ion battery
	Rating Capacity	2500mAh	State of Charge at shipment: 30% max.
	Safety Standard of Battery	IEC62133, UN38.3	
Output	Rated Voltage	+3.3V +5V +12V -12V +5VSB	
	Rated Current	8A 8A 14A 0.5A 1A	Standard value at measuring of input/output characteristics
	Max. Current / Power	12A 12A 20A 0.5A 1A	Max. output power: 245.4W Refer to the derating condition
		66.4W max. 240W 6W 5W	
		240.4W max. 245.4W max.	
	Peak Current / Power	22A 22A 28A 0.5A 2A	Peak output power: 346W Time: 5 sec or less Duty ratio of repetitive load: 10% or less (Refer to <Fig.2> Duty Ratio.)
		113W max. 336W 6W 10W	
		336W max. 346W max.	
	Rated Current at Backup Operation	6A 6A 12A 0.5A 1A	
	Max. Current / Power at Backup Operation	12A 12A 16A 0.5A 2A	
	66.4W max. 192W 6W 10W		
	200W max. 205W max.		
Min. Current	0A 0A 0A 0A 0A		
Total Voltage Accuracy (%)	±5 max. ±5 max. ±5 max. ±10 max. ±5 max.	Accuracy against output voltage value including temperature and time lapse drifts as well as input/load regulation.	
Max. Ripple Voltage (mVp-p)	50 max. 50 max. 120 max. 120 max. 50 max.	Connect an electrolytic capacitor (47µF) and a ceramic capacitor (0.1µF) on the test board and measure with an oscilloscope of 100MHz bandwidth. The test board shall be separated from load wires and within 150mm from the output terminals. *Characteristic data: Fig.17	
Max. Spike Voltage (mVp-p)	100 max. 100 max. 200 max. 200 max. 100 max.		
Protection	Over Current Protection	OCP point (A) 23 min. 23 min. 29 min. Short circuit protection	No loads except for the measured voltage
		Method All outputs of +3.3V, +5V, +12V and -12V are shut down. Hold down current limiting All outputs shut down	All outputs shut down if +5VSB is short (automatic recovery)
		Recovery Reclosing AC input, or switching PS_ON# signal from 'H' to 'L' Automatic recovery	AC input re-entry time interval is 270s or longer
	Over Current Protection at Backup Operation	OCP point (A) 23 min. 23 min. 20 min. Short circuit protection	No loads except for the measured voltage
		Method All outputs shut down. Hold down current limiting All outputs shut down	All outputs shut down if +5VSB is short (automatic recovery)
		Recovery Reclosing AC input, and switching PS_ON# signal from 'H' to 'L' Automatic recovery Reclosing of AC input	
Over Voltage Protection	OVP point (V) 3.7~4.3 5.7~7.0 13.4~15.6 -- --		
	Method All outputs of +3.3V, +5V, +12V and -12V are shut down. -- --		
	Recovery Reclosing AC input, or switching PS_ON# signal from 'H' to 'L' -- --	AC input re-entry time interval is 270s or longer	
Environment	Operating Temp/ Humidity	0-60°C*/10-90%	*Refer to <Fig.3> Temperature derating. No condensation
	Storage Temp./Humidity *2	-20-70°C/10-90%	No condensation
	Vibration	2G, 10-55Hz, 10 sweep cycles in each X, Y, Z direction	Follow JIS-C-60068-2-6 at no operation
	Mechanical Strength	Lift one bottom edge 50mm high with the opposite edge placed on a test bench, and let it fall. Repeat 3 times on the other three edges as well, and no malfunction shall be observed.	Follow JIS-C-60068-2-31 at no operation
Insulation	Dielectric Strength	AC input - FG/DC output: 1500VAC for 1 minute	Cut-off current 10mA
	Insulation Resistance	AC input - FG/DC output: 50MΩ min.	At 500VDC
	Leakage Current	0.2mA max. (100VAC) / 0.4mA max. (200VAC) / 0.5mA max. (240VAC) *Characteristic data: Fig.7	
EMC	Line Noise Immunity	±2,000V (pulse width of 100/1000ns, cycle period of 30 to 100Hz, normal/common mode with positive/negative polarity for 10 minutes)	There shall be no fluctuation of DC output or malfunction.
	Electrostatic Discharge	EN61000-4-2 compliant	
	Radiated, Radio-Frequency, Electromagnetic Field	EN61000-4-3 compliant	
	Fast Transient Burst	EN61000-4-4 compliant	
	Lightning Surge	EN61000-4-5 compliant	
	Radio Frequency Conducted Immunity	EN61000-4-6 compliant	
	Power-Frequency Magnetic Field Immunity	EN61000-4-8 compliant	
	Voltage dips/Regulation	EN61000-4-11 compliant	
Conducted Emission	VCCI/FCC/CISPR22-B/EN55022 class B compliant *Characteristic data: Fig.8, 9	To be measured on the single power supply	
Harmonic Current Regulations	IEC 61000-3-2 class D compliant	At rated input and load	
Others	Safety Standards	UL62368, CSA62368 (c-UL) certified, EN62368, PSE (ordinance clause 2) compliant, CE Marking	Class I equipment: Embedded type power supply
	Cooling System	Forced air cooling: thermal-sensing variable speed fan embedded	Fan speed changes according to operating temp. and load condition. Maximum rotation during backup operation.
	Output Grounding	Connected chassis (FG)	
	Reliability Grade	FA (Industrial equipment grade to use double-sided PCB with plated through hole)	Original design category
	MTBF	50,000 H min	Based on EIAJ RCR-9102
	Weight	1.7 kg typ	
	Warranty	Three years after delivery. If any defects belong to us, the defective unit shall be repaired or replaced at our cost.	Except for errors caused by operation not specified in this specification.

*1 Charging current equal to or less than 100µs into X-capacitor in input filter circuit shall not be defined as inrush current.
*2 Re-charging once at least per year (or 6 months if available) is required for 6 months or longer storage.
When re-charging is not conducted beyond the period, the battery may not recover enough capacity.
1 year or less storage : -20 to lower than +20°C/10-95%
Within 90 days storage : -20 to lower than +40°C/10-95%
Within 30 days storage : -20 to lower than +50°C/10-95%
If the storage temperature exceeds 50°C, the battery shall be stored separately.
When the input voltage is applied after long term storage, the power supply may charge the battery for about 8 hours.

General Specification (Items are provided at normal temperature and humidity unless otherwise specified.)

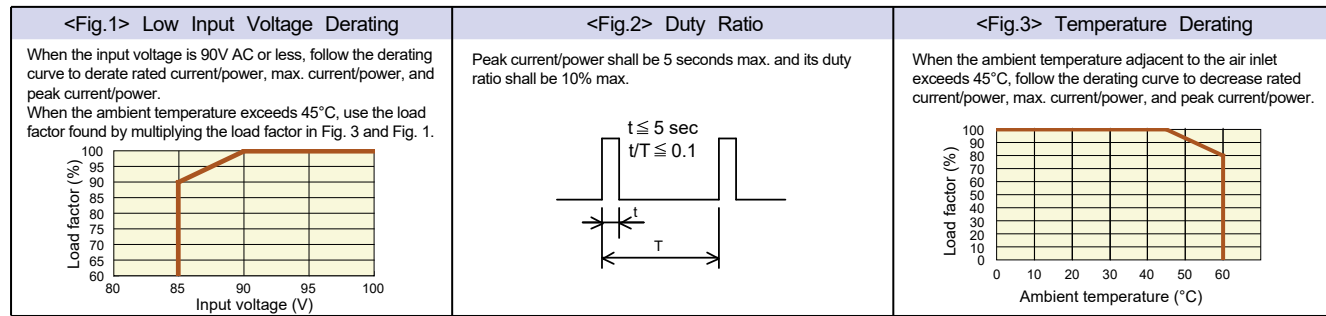

Signal Input/Output Specification (Items are provided at normal temperature and humidity unless otherwise specified.)

Items	Specification	Note	
Input Signal	Output ON/OFF control signal (PS_ON#)	+3.3V, +5V, +12V and -12V outputs will turn on at 'L' input. +3.3V, +5V, +12V and -12V outputs shut down at 'H' or 'OPEN' input. (Battery connection shuts off when 'H' or 'OPEN' is received at backup operation.)	MAIN1 connector 22 pin, SIG connector 6 pin
	+3.3V SENSE	Input terminal for voltage detection of +3.3V; voltage drop of +side output cable is compensated when connected to load end.	MAIN1 connector 2 pin
	Battery shutdown signal for TTL (SHUT_DOWN_T)	Battery connection shuts off at 'L' input with 60ms or longer. (Valid only at battery backup operation)	SIG connector 2 pin
	Battery shutdown signal for RS232C (SHUT_DOWN_R)	Battery connection shuts off with 'positive (2.4V or higher)' input. (60ms or longer)	Apply only to HN5P5-350P-S20-B1V Front panel RS232C connector 4 pin
	Fan control signal (FAN_C)	Control terminal of a fan motor. Fan motor operates at a maximum speed upon receipt of 'L'. (Disabled during battery backup operation)	SIG connector 4 pin
Output Signal	Normal output signal (PWR_OK)	'H' is delivered when +5V output is ON.	MAIN1 connector 21 pin
	Fan monitoring signal (FAN_M)	Two pulses per rotation of individual motors are delivered. Duty ratio of square wave shall be 0.5 (typical). (Interval between the signals becomes longer at low speed and shorter at high speed.) The signal stops 'L' or 'OPEN' when the fan stops operating due to malfunction.	SIG connector 5 pin
	Power failure detection signal for TTL (AC_FAIL_T)	'OPEN' is delivered at low AC input voltage or power failure. (Detection voltage: 75VAC typical, Detection delay time: 16 to 40ms after power failure at rated input/output)	SIG connector 1 pin At rated output
	Power failure detection signal for RS232C (AC_FAIL_R)	'-9V typical' is delivered at low AC input or power failure detection. (Detection voltage: 75VAC typical, Detection delay time: 16 to 40ms after input/output)	Apply only to HN5P5-350P-S20-B1V Front panel RS232C connector 8 pin At rated output
	Power failure detection signal for USB (AC_FAIL_U)	Data signal equivalent to 'Negative' of AC_FAIL_R signal is delivered at low AC input or power failure detection. (Detection voltage: 75VAC typical, Detection delay time: 16 to 40ms after power failure at rated input/output)	Apply only to HN5P5-350P-S20-B6V Front panel USB connector At rated output
	Low battery voltage signal for TTL (BATT_LOW_T)	'OPEN' is delivered when battery terminal voltage falls down to 16V typical. ('OPEN' is delivered when a battery pack is not connected)	SIG connector 3 pin
	Low battery voltage signal for RS232C (BATT_LOW_R)	'-9V typical' is delivered when battery voltage falls down to 16V typical. ('-9V typical' is delivered when a battery pack is not connected.)	Apply only to HN5P5-350P-S20-B1V Front panel RS232C connector 1 pin
Low battery voltage signal for USB (BATT_LOW_U)	Data signal equivalent to 'Negative' of BATT_LOW_R signal is delivered when battery voltage falls down to 16V typical. (Data signal equivalent to 'Negative' of BATT_LOW_R signal is delivered when a battery pack is not connected.)	Apply only to HN5P5-350P-S20-B6V Front panel USB connector	
CHARGE	'L' is delivered when charging a battery.	SIG connector 8 pin	

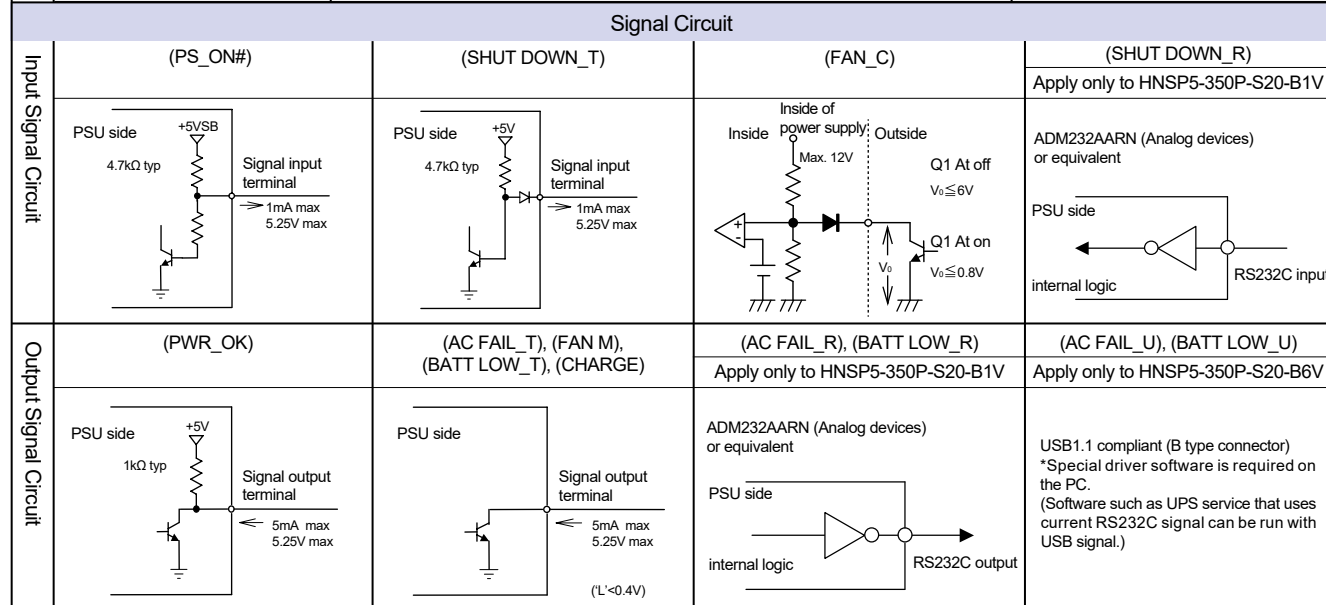

Sequence Timing Chart

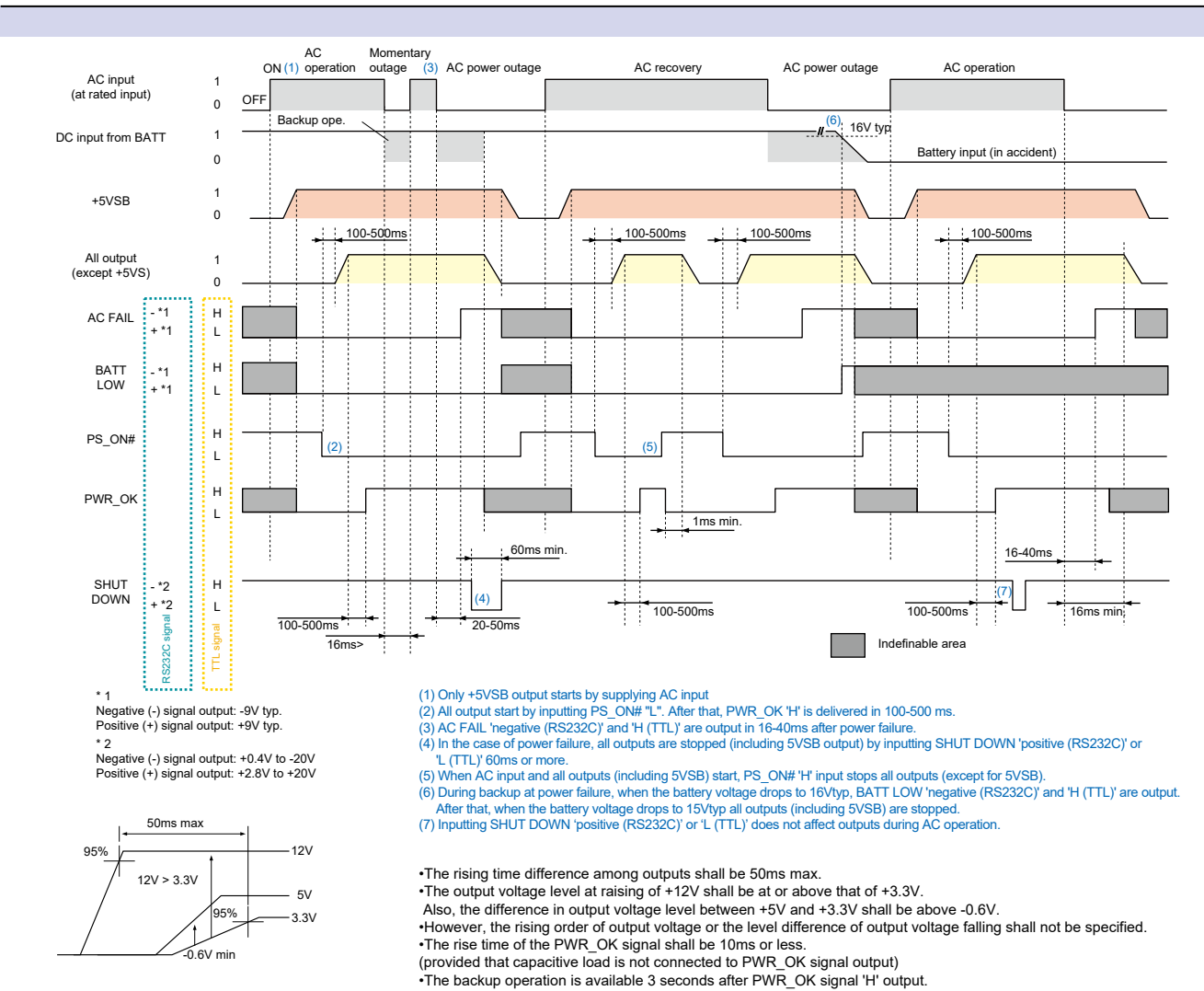

Block Diagram

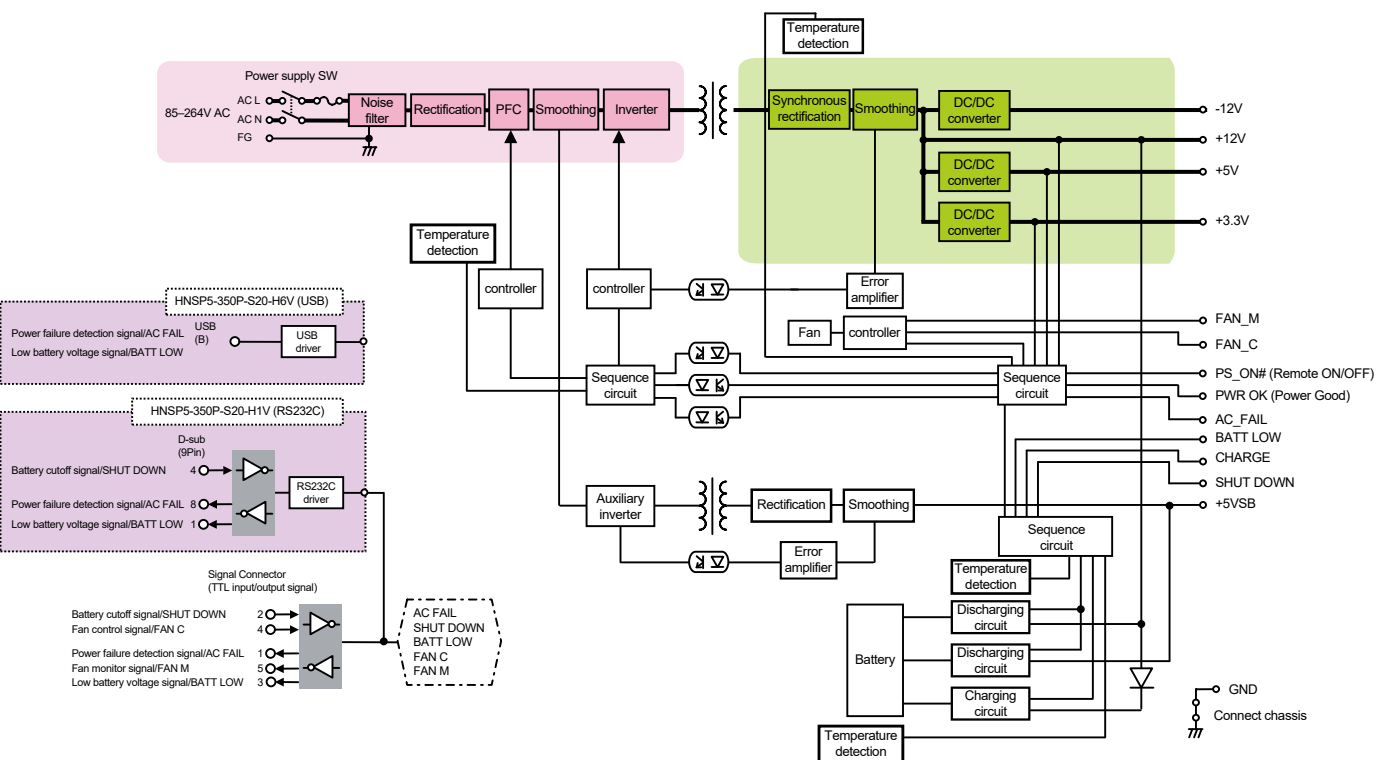

Outline Drawing

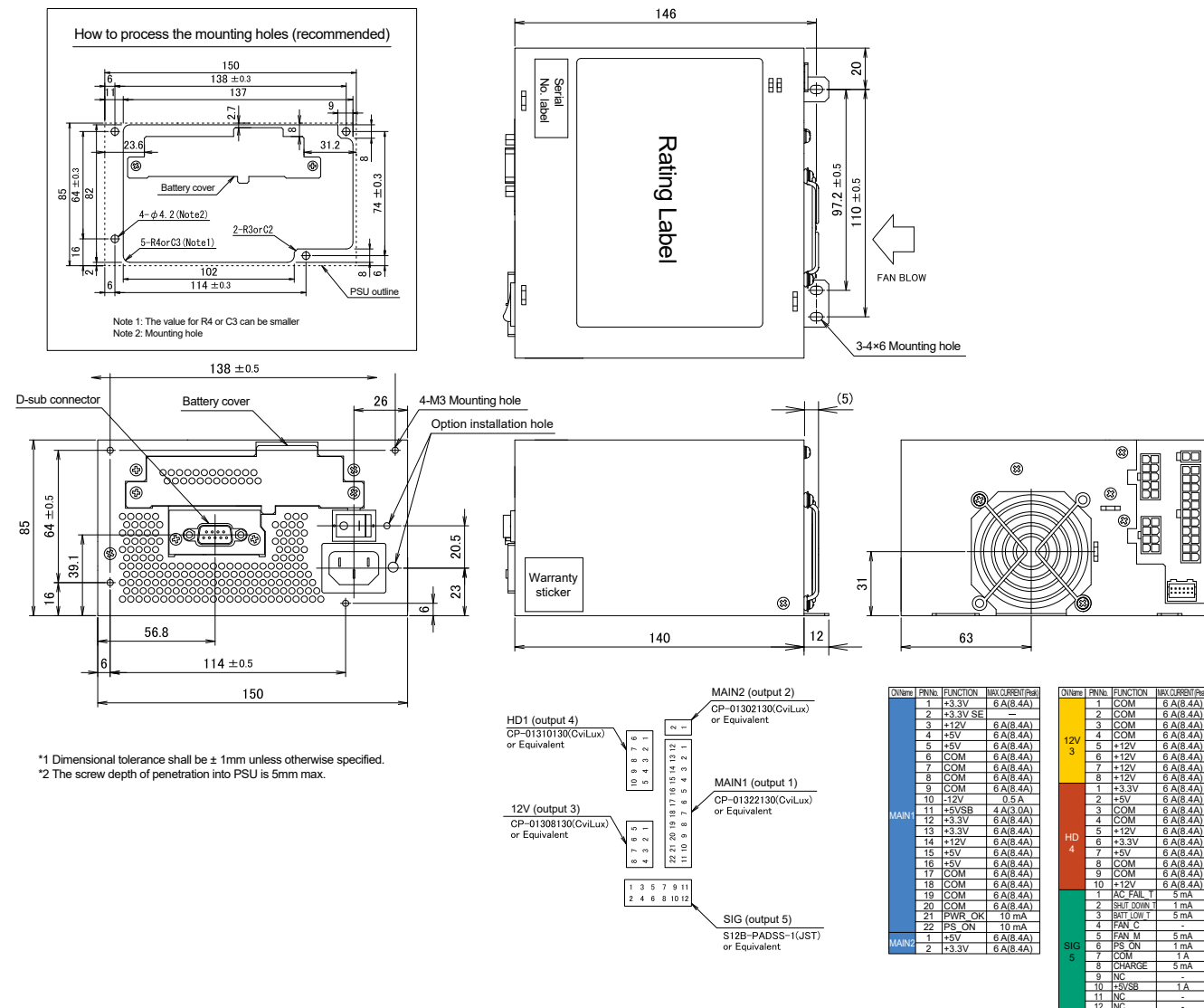

Battery replacement

• Replacement preparation
The battery is replaceable only when the unit is turned off (no output). If the unit is in operation (outputting power), turn it off and disconnect it from the AC cord before replacing the battery.

- Battery replacement
- (1) Use a screwdriver to remove the 2 battery cover mounting screws.
- (2) Remove the battery cover.
- (3) Remove the battery connector and 2 battery harness connectors.
- (4) Grasp the handle (seal) and remove the battery.
- (5) Install the new battery by reversing the above procedure.

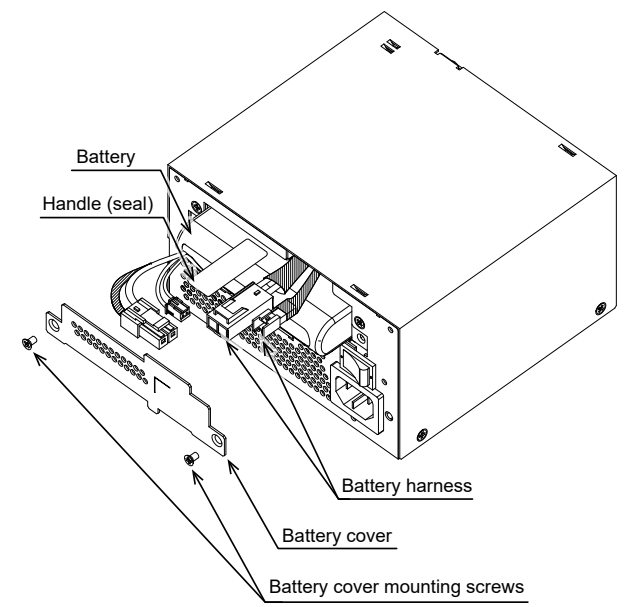

- Note
- Do not use a battery other than the specified one.
 - If the battery is leaking, do not touch the fluid.
 - Do not drop or give a strong impact on the battery.
 - Do not hold the harness when removing the battery.
 - Do not put the battery into the fire, decompose, modify, or destroy it.

Options (Sold separately)

Detachable output harness		Output port allocation			
Model	Length and type of connector				
Main harness (MAIN)					
WH-M2022-500	500±10 20Pin				
WH-M2022-300	300±10 20Pin				
WH-M2422-500	500±15 24Pin				
12V harness (12V)					
WH-V0808-500	500±15 12V 8Pin				
WH-V0408-500	500±15 12V 4Pin				
WH-VG208-500	500±15 PCI-E 6Pin				
WH-VV208-500-02	500±10 12V 8Pin 12V 8Pin				
WH-VG208-500-02	500±10 12V 8Pin PCI-E 6Pin				
HD harness (HD)					
WH-PP610-850	550±15 150±15 150±15 Peripheral (HD)				
WH-PS610-850	550±15 150±15 150±15 FD				
WH-PS710-850	550±15 150±15 150±15 S-ATA				
WH-PS810-1000	550±15 150±15 150±15 150±15				

Acceptable cables
1 model 1 model 1 model

Cable			
Photos	Model	Category	Description
	WH2601-02	RS232C communication cable	For Windows 2000/XP/Vista/7 It is available for power supplies with RS232C signal unit. [RoHS]
	WH2967	USB communication cable	USB communication cable It is available for power supplies with USB signal unit. [RoHS]
	WH2753-02	AC power cord	125VAC 12A (tracking resistance type) [PSE]

Software			
Photos	Model	Category	Description
	NSP Pro 2 (CD Media)	Automatic shutdown software	For Windows 2000/XP/Vista/7/10

* NSP Pro 2 can be downloaded for free from our website (NSP Pro 2 product page).
* Windows 2000 and XP can also use UPS service, which is the standard service of the OS.

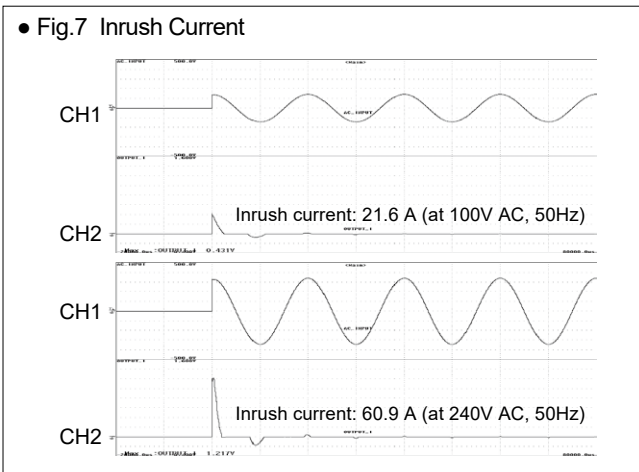
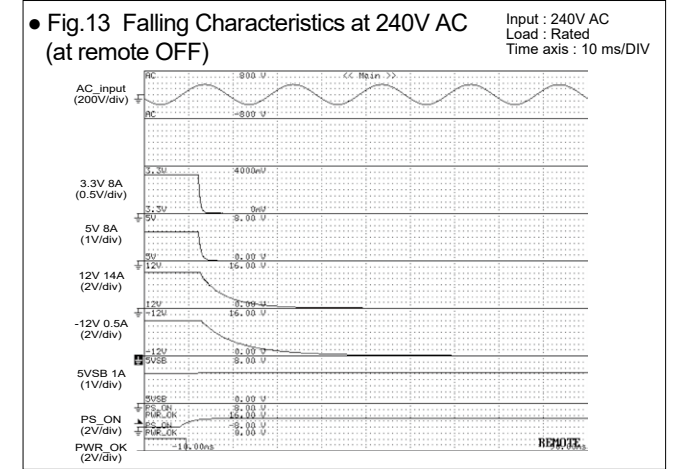
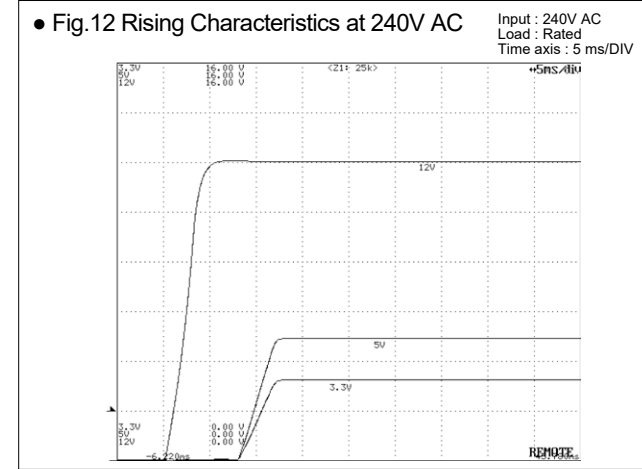
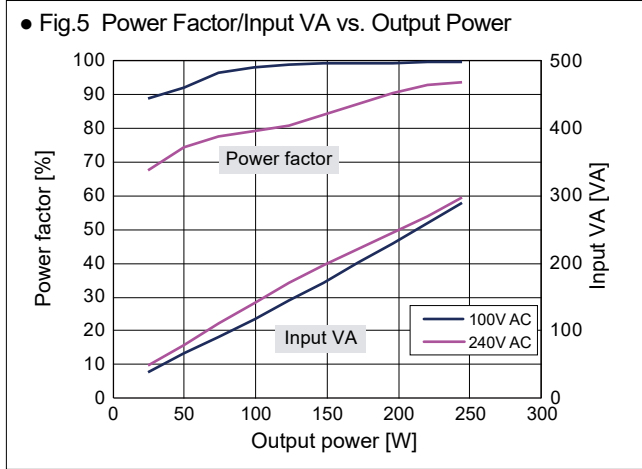
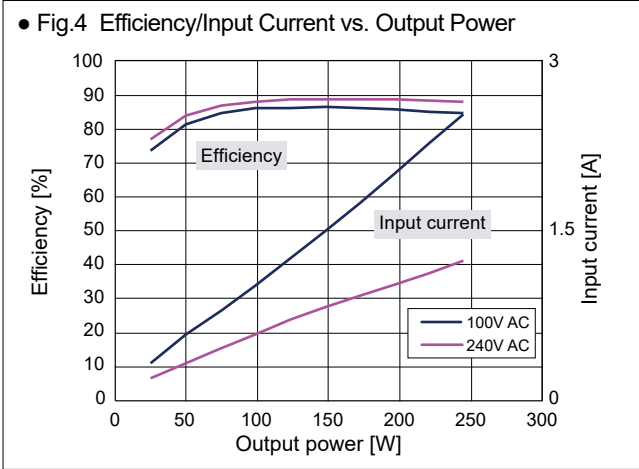

• Fig.7 Leakage Current

Input : 100, 200, 240V AC
Load : Rated load and Min. load

	Rated load	Min. load
100V AC	0.05mA	0.06mA
200V AC	0.11mA	0.11mA
240V AC	0.14mA	0.14mA

• Fig.14 Output Hold-up Time (without the battery)

Temp.	Input voltage	Hold-up time	
		Output 90% or less	PWR_OK drop
-5°C	100V AC	19.6ms	15.9ms
	240V AC	19.9ms	16.2ms
25°C	100V AC	20.2ms	17.2ms
	240V AC	21.0ms	17.4ms
45°C	100V AC	21.6ms	18.6ms
	240V AC	22.4ms	19.2ms
65°C	100V AC	28.0ms	24.4ms
	240V AC	27.9ms	24.3ms

*Refer to p.2 about the output hold-up time with the battery (backup time for blackout).

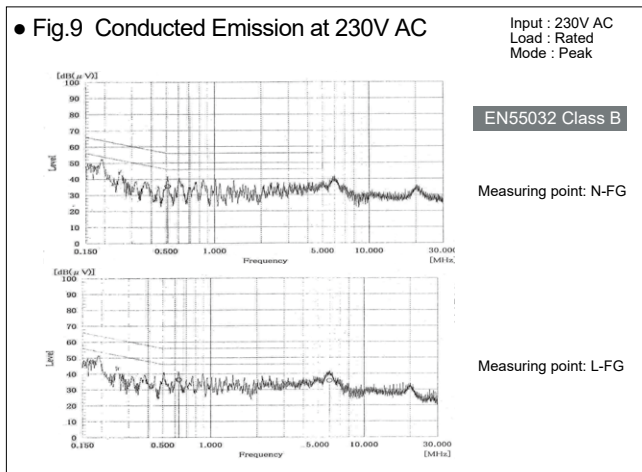
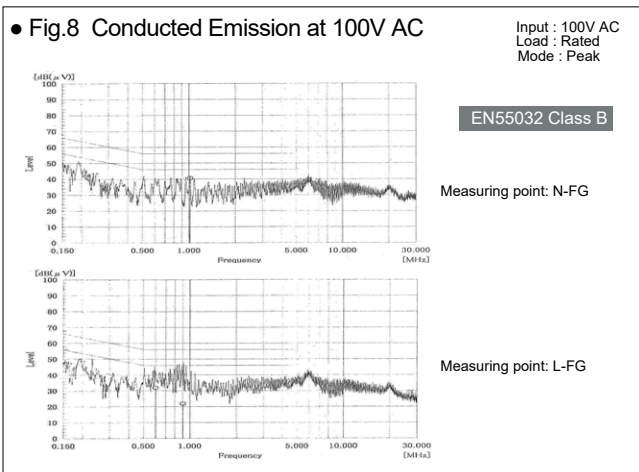
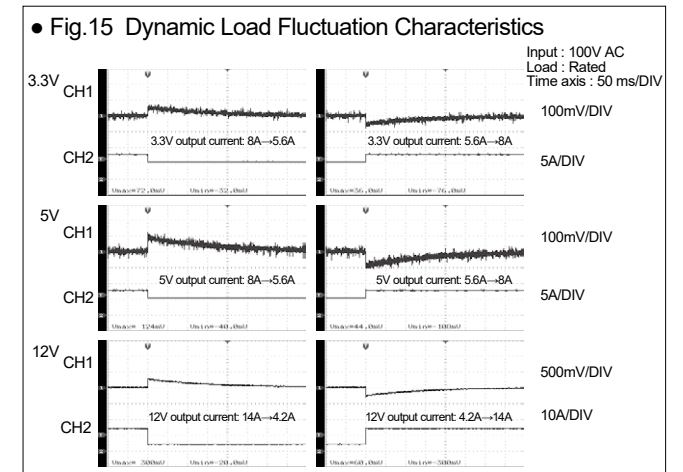

• Fig.16 Output Voltage Regulation (Load Fluctuation)

Output	Min. load	Rated load	
		12V	14A
12V output	0A	14A	14A
5V output	0A	8A	8A
3.3V output	0A	8A	8A

AC input	85V	100V	240V	264V
3.3V output (min.)	3.329V	3.328V	3.323V	3.323V
3.3V output (rated)	3.255V	3.254V	3.252V	3.252V
5V output (min.)	5.063V	5.063V	5.050V	5.051V
5V output (rated)	4.906V	4.904V	4.903V	4.903V
12V output (min.)	12.171V	12.172V	12.180V	12.179V
12V output (rated)	12.054V	12.053V	12.056V	12.056V

• Fig.17 Ripple and Spike Voltage

Temp.	AC Input voltage	Load: Rated									
		+3.3V Ripple (mV)	+3.3V Noise (mV)	+5V Ripple (mV)	+5V Noise (mV)	+12V Ripple (mV)	+12V Noise (mV)	-12V Ripple (mV)	-12V Noise (mV)	+5VSB Ripple (mV)	+5VSB Noise (mV)
-5°C	100V	20.5	30.3	26.2	39.4	26.7	58.4	45.1	63	30.5	48.9
	240V	20.4	30.2	26.0	39.5	26.7	58.6	45.4	63.8	30.6	49.8
25°C	100V	19.3	28.1	23.9	37.2	24.8	54.1	34.6	48.8	23.8	40.9
	240V	18.6	28.4	23.6	35.8	24.5	56.4	34.8	49.9	23.2	41.4
50°C	100V	19.1	28.7	23.4	33.2	19.9	49.1	25.9	38.5	20.4	37.5
	240V	18.3	26.5	21.6	33.3	21.0	48.9	25.5	37.3	19.6	37.9
65°C	100V	16.0	23.9	19.3	28.9	18.0	44.9	20.0	33.4	18.2	37.3
	240V	15.3	22.8	18.2	28.0	18.0	42.6	20.0	30.7	17.5	37.1

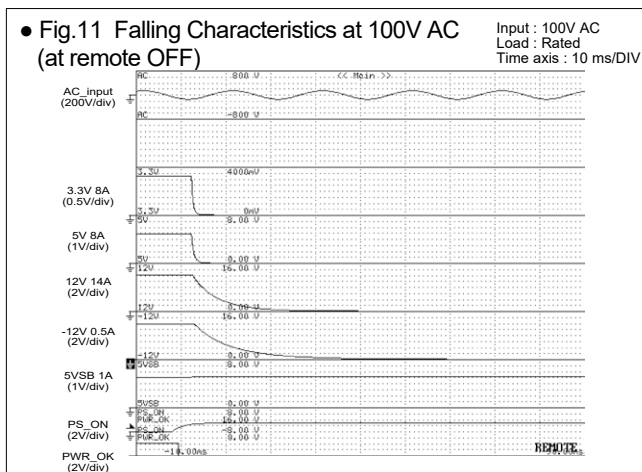
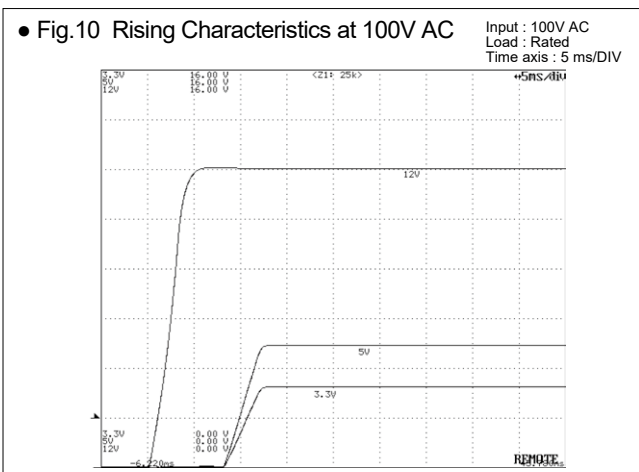

• Fig.18 Ambient Temperature vs. Lifetime Expectancy (without battery)

Input : 100V AC Load : Rated

■ Electrolytic capacitors

Power supply intake temperature	25°C	35°C	45°C
Lifetime expectancy	Approximately 15 years		

* The lifetime shall be 15 years at longest due to deterioration of the sealing rubber characteristics.

■ Fan

Fan ambient temperature	25°C	45°C
Lifetime expectancy	Approx. 11.4 years	Approx. 9.5 years

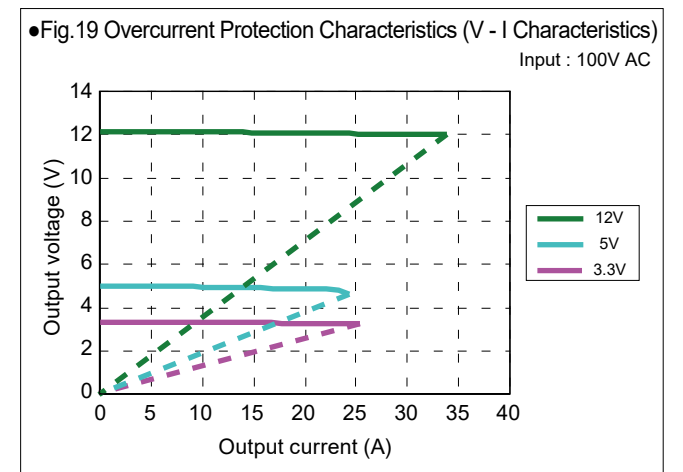



Nipron Co., Ltd.

●Sales department and R&D department
1-3-30, Nishinagasu-cho, Amagasaki-city, Hyogo, 660-0805, Japan.
TEL: +81-6-7220-3657 FAX: +81-6-6487-2212
URL: <http://www.nipron.com/>

w w w . n i p r o n . c o m

●Contact us

- Do not copy. Copyright© 2023 Nipron Co.,Ltd
- Do not use our products for special purposes including nuclear power, airplanes, military, space projects, and anything that directly involves human life.
- Company names, product names and logos in the catalog are trademarks of each company or registered trademarks.
- Specifications, design and prices in the catalog are subject to change without prior notice.
- When using a product, please request for a product specifications and make sure to check all the items for proper use.