

Rack Mount Power Supply pNSP2U-550P-AAS

With 4 Patents

Nipron's Unique, Primary Redundant Power Supply

RoHS Directive

ERP2U
 Continuous Max. **430W** Peak Power **550W**

pNSP2U-550P-AAS

Model	Description	Stock
pNSP2U-550P-AAS	—	Standard stock
Model Name Coding pNSP2U - 550P - A A S ① ② ③ ④ ⑤ ⑥		
	1. Series name 2. Output power 3. Peak output compliant	4. Primary input unit (upper side) 5. Primary input unit (lower side) 6. Secondary DC output unit

Features

- Operation efficiency has been greatly improved by our unique technology in comparison with existing redundant power supplies. Lower inside temperature rise and high reliability are achieved.
- Big power of 550W with SSI-ERP2U specification including even one unit operation.
- All outputs is equipped with entirely perfect isolated voltage control circuit to stably drive up-to-date CPU.
- Output connector method adopted to meet a variety of requirements.
- Flexible setting of power distribution ratio from 2 inputs by external signal
- Defective unit is notified by a signal and LED display.
- In combination with Primary unit, more safety and lower cost effectiveness can be chosen.
- Sole AC power supply installation is also available

Other Services

2U server case with Primary Redundant PSU (pNSP2U-1000P//550P//330P) installed is available.
 Also, server with pNSP2U-1000P//550P//330P PSU installed is available.



Refer to "Product Page Guideline" on p.11

Safety standard / Approval	UL	CSA	EN	CE	CCC
Reliability Grade	HFA	FA	HOA	OA	

Function

DC start	RS 232C	USB	TTL	PFC	Silence	5VSB FAN	TSFC FAN	Connection	RoHS
----------	---------	-----	-----	-----	---------	----------	----------	------------	------

*5VSB FAN is only equipped in a secondary side.

Input

AC input	85 - 264V (worldwide range)
----------	-----------------------------

Output

Output voltage	+3.3V	+5V	+12V1	+12V2	+12V3	-12V	+5VSB
Max. current / max. power (continuous)	20A	20A	18A	12A	10A	0.5A	2A
	Total 25A		Total 35A			Total 427.6W	
Peak current / peak power (5 sec max.)	20A	20A	18A	12A	16A	0.5A	2A
	Total 25A		Total 44A			Total 550W	
Min. current	0A	0A	0A	0A	0A	0A	0A

Dimensions

W×H×D (mm)	108×83.8×400
------------	--------------

Output connector (optional component)

Main 20+4pin	Main 24pin	Main 20pin	AT	AUX	12V 4pin	12V 8pin	PCI-E 6pin	PCI-E 6+2pin	HDD	S-ATA	FDD
--------------	------------	------------	----	-----	----------	----------	------------	--------------	-----	-------	-----

*Refer to p.229 "Detachable output harness" for details

General Specification Condition: at normal temperature and humidity unless otherwise specified

Items		Specification							Measurement conditions, etc.		
AC Input	Rated Voltage	100 - 240 VAC (85* - 264 VAC) (Startup voltage: 80 - 90 VAC)							Worldwide range *Refer to Fig.1		
	Input Frequency	50 / 60Hz							47 - 63Hz		
	Efficiency	74% typ. (100 VAC), 77% typ. (240 VAC) *Characteristic data: Fig.4									
	Power Factor	99% typ. (100 VAC), 98% typ. (240 VAC) *Characteristic data: Fig.5									
	Inrush Current	40A peak *Characteristic data: Fig.6							At rated input/output		
AC Input	Input VA	610VA max. *Characteristic data: Fig.5							At rated input and max. output		
		760VA max.							At rated input and peak output		
Output	Rated Voltage	+3.3V	+5V	+12V1	+12V2	+12V3	-12V	+5VSB			
	Rated Current (Note 1)	12A	12A	12A	7A	7A	0.5A	2A			
	Max. Current / Power (Note 1)	20A	20A	18A	12A	10A	0.5A	2A	Max. output power: 427.6W		
		25A max.		35A max.							
		427.6W max.									
	Peak Current / Power (Note 1)	20A	20A	18A	12A	16A	0.5A	2A	Peak output power: 550W Time: 5 sec or less Duty ratio of repetitive load: 10% or less *Refer to Fig.2		
		25A max.		44A max.							
		550W max.									
	Min. Current	0A	0A	0A	0A	0A	0A	0A			
	Total Voltage Accuracy (%)	±4 max.	±4 max.	±5 max.	±5 max.	±5 max.	±5 max.	±5 max.	Total accuracy of temperature, input, and load fluctuations		
Max. Ripple Voltage (mVp-p)	50 max.	50 max.	150 max.	150 max.	150 max.	150 max.	50 max.	Two wires are coming out from the output connector and connected into one at the edge. 10μF electrolytic capacitor and 0.1μF film capacitor are placed on it and it is measured. *Characteristic data: Fig.17			
Max. Spike Voltage (mVp-p)	100 max.	100 max.	200 max.	200 max.	200 max.	200 max.	100 max.				
Protection	Overcurrent Protection	OCP Point (A)	14.3 min.	14.3 min.	18.2 min.	12.6 min.	16.8 min.	Short protection		All other outputs are at rated input/output.	
		Method	26.3 min.					26.3 min.		Short protection	All other outputs are at no load and rated input voltage.
		Recovery	All outputs shutdown except for +5VSB					Automatic recovery		*All outputs shutdown except for +5VSB	
	Overvoltage Protection	OVP Point (V)	3.9 - 4.5	5.7 - 6.5	13.3 - 14.5	13.3 - 14.5	13.3 - 14.5	-			
		Method	All outputs shutdown except for +5VSB					-			
		Recovery	Reclosing AC input					-			
Alternating Operation Function (AC Unit)	When two input units are in use, each unit switches operation in 2 sec (4 sec cycle) to avoid temperature concentration on one unit.							To correspond to +3.3V, +5V, +12V1, +12V2, and +12V3 in the case that operation priority is not specified			
Environment	Operating Temp. / Humidity	0 to 60°C* / 10 to 90%							*Refer to Fig.3 No condensation		
	Storage Temp. / Humidity	-25 to 70°C / 10 to 95%							No condensation		
	Vibration	Displacement amplitude: 0.075mm (10-55Hz), Sweep cycles: 10, Test duration: 45 minutes each axis							JIS-C-0040-1999, at no operation		
	Mechanical Shock	Lift one bottom edge up to 50mm and let it fall. Number of bumps: 3 each of 4 edges							JIS-C-0043-1995, at no operation		
Insulation	Dielectric Strength	AC input - DC output/FG and between AC inputs: 1500 VAC for 1 minute							Cut off current: 20mA		
	Insulation Resistance	AC input - DC output/FG and between AC inputs: 50MΩ min.							At 500 VDC		
	Leakage Current	0.5mA max. (100 VAC) / 1mA max. (240 VAC) *Characteristic data: Fig.7							YEW. TYPE3226 (1kΩ) or equivalent per one input unit		
EMC	Line Noise Immunity	±2000V (pulse width: 100/1000ns, repetitive cycle: 30-100Hz, normal/common mode with pos./neg. polarity for 1 minute)							Measured by INS-410 No fluctuation of DC output or malfunction		
	Electrostatic Discharge	EN61000-4-2 compliant									
	Radiated, Radio-Frequency EM Field	EN61000-4-3 compliant									
	Fast Transient Burst	EN61000-4-4 compliant									
	Lightning Surge	EN61000-4-5 compliant									
	RF Conducted Immunity	EN61000-4-6 compliant									
	Magnetic Field Immunity	EN61000-4-8 compliant									
	Voltage Dip / Regulation	EN61000-4-11 compliant									
	Conducted Emission	VCCI-A, FCC-A, EN55022-A compliant *Characteristic data: Fig.8 and 9							Measured by single unit at rated output		
	Harmonic Current Regulation	IEC61000-3-2 (ver.2.1) Class D, EN61000-3-2 (A14) Class D compliant							At rated input/output		
Others	Safety Standards	UL60950, CSA60950-1(c-UL) certified									
	Cooling System	Forced air cooling							Input unit: Lock sensing signal equipped To stop at 'H' of PS_ON# signal Output unit: Pulse sensing signal equipped. Low speed at 'H' of PS_ON# signal		
	Output Grounding	Connected chassis (FG)									
	Output Hold-up Time	PWR_OK holds up 20ms min. after AC failure *Characteristic data: Fig.14							At rated output		
	Reliability Grade	FA (industrial equipment grade, double-sided PCB with plated through hole)							Follow our standard		
	MTBF	53,000H min. (at one AC unit operation)							Based on EIAJ RCR-9102		
	Weight	4.6kg typ.									
Warranty	3 years after delivery. If any faults belong to us, the defective unit shall be repaired or replaced at our cost.							Except for errors caused by operation not listed			

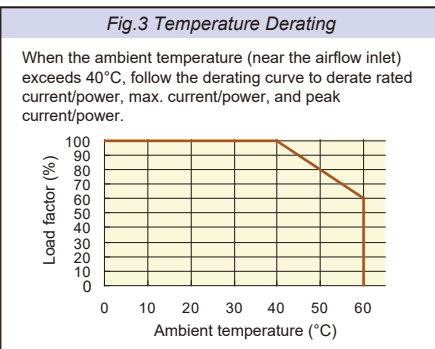
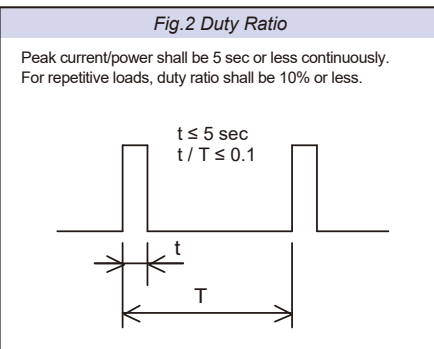
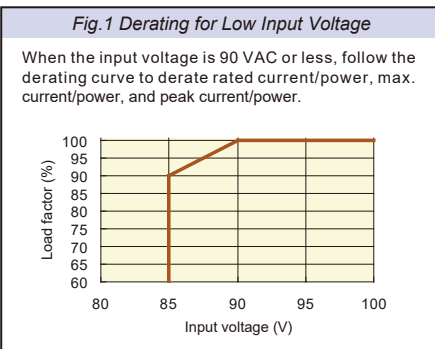

(Note 1) This current and power is provided that both of upper and lower unit are connected to the output unit. For long-term operation with single input unit, install an optional dummy input unit, pNSP1U-550P-P, to the upper or lower side to run. Also, In the case that only one input unit (upper or lower) is operated without the other unit or dummy unit installed, another 95% derating in addition to "Input voltage vs. Output derating" is required.

BRAIN Power Supply
Rack Mount Power Supply
Non-backup Power Supply

Signal Input / Output Specification Condition: at normal temperature and humidity unless otherwise specified

	Items	Specification	Note
Input Signal	Output ON / OFF Control Signal (PS_ON#)	+3.3V, +5V, +12V1, +12V2, +12V3, and -12V outputs shutdown with 'H' or 'OPEN' input.	Signal input between the pin 16 of MAIN connector and COM pin
	+3.3V SENSE	The input terminal to detect the voltage of +3.3V output; by connecting to the load terminal, only the line drop of the + side of the output cable is compensated.	The pin 1 of MAIN connector, the pin 8 of SIG connector (the pin 8 of SIG connector is given priority if both are connected.)
	Operation priority signal_1 (PRIORITY_1)	Upon receipt of 'L', the upper unit starts to provide +3.3V, +5V, +12V1, +12V2, and +12V3 output power. (If the upper unit is disconnected, failed, or blackout occurs, the lower unit starts to provide power regardless of this signal. Also, when both of PRIORITY_1 and PRIORITY_2 go 'L', the lower unit provides power. (PRIORITY_2 signal has the priority.))	The pin 13 of SIG connector
	Operation priority signal_2 (PRIORITY_2)	Upon receipt of 'L', the lower unit starts to provide +3.3V, +5V, +12V1, +12V2, and +12V3 output power. (If the lower unit is disconnected, failed, or blackout occurs, the upper unit starts to provide power regardless of this signal. Also, when both of PRIORITY_1 and PRIORITY_2 go 'L', the lower unit provides power. (PRIORITY_2 signal has the priority.))	The pin 12 of SIG connector
Output Signal	Normal Output Signal (PWR_OK)	'H' signal is delivered at +5V normal output (detection delay time: 200 - 500ms).	The pin 8 of MAIN connector
	Input fail detection signal_1 (Vin FAIL_1)	This signal goes 'OPEN' when the upper unit has no AC input. (detection voltage: 75 VAC typ., detection delay time: 20 - 40ms after AC input failure)	The pin 4 of SIG connector
	Input fail detection signal_2 (Vin FAIL_2)	This signal goes 'OPEN' when the lower unit has no AC input. (detection voltage: 75 VAC typ., detection delay time: 20 - 40ms after AC input failure)	The pin 3 of SIG connector
	Fan signal (FAN ALARM_1):Upper Input unit (FAN ALARM_2):Lower Input unit	This signal goes 'OPEN' when fan keeps locked. However, it is undefined when PS_ON# signal is 'H'.	FAN ALARM_1:The pin 10 of SIG connector FAN ALARM_2:The pin 9 of SIG connector
	(FAN M_S): Output unit	Two cycle pulses per one rotation of the fan motor are delivered. (4600rpm typ. at PS_ON# signal 'L', and 1800rpm typ. at PS_ON# signal 'H')	The pin 11 of SIG connector
	Input unit failure signal_1 (UNIT FAIL_1)	'H' is delivered when the upper unit is not connected, failed, blackout, or Input unit's fan is locked, or PRIORITY_2 signal goes 'L'. However, when PS_ON# signal goes 'H', 'L' is delivered. Also, when total power of +3.3V, +5V, +12V1, +12V2, and +12V3 is 20W or less this signal goes undefined. (Detection delay time is 2 to 10 sec)	The pin 14 of SIG connector
	Input unit failure signal_2 (UNIT FAIL_2)	'H' is delivered when the lower unit is not connected, failed, blackout, or Input unit's fan is locked, or PRIORITY_1 signal goes 'L'. However, when PS_ON# signal goes 'H', 'L' is delivered. Also, when total power of +3.3V, +5V, +12V1, +12V2, and +12V3 is 20W or less this signal goes undefined. (Detection delay time is 2 to 10 sec)	The pin 15 of SIG connector
	Input connection signal_1 (UNIT IN_1)	5±1V voltage is delivered when the upper unit is connected.	The pin 8 of SIG connector
	Input connection signal_2 (UNIT IN_2)	5±1V voltage is delivered when the lower unit is connected.	The pin 7 of SIG connector
	Input unit failure LED (UNIT FAIL LED_1)	LED turns in red when Input unit failure signal_1 or Input fail detection signal_1 goes 'H' and when the fan of the upper unit is locked at PS_ON# signal 'L'. Other than that, it turns in green. However, it is undefined right after PS_ON# goes 'H'. It may turn in red for several seconds depending on loads.	
Input unit failure LED (UNIT FAIL LED_2)	LED turns in red when Input unit failure signal_2 or Input fail detection signal_2 goes 'H' and when the fan of the lower unit is locked at PS_ON# signal 'L'. Other than that, it turns in green. However, it is undefined right after PS_ON# goes 'H'. It may turn in red for several seconds depending on loads.		

Signal Circuit

Input Signal Circuit	(PS_ON#)	(PRIORITY_1, 2)	
Output Signal Circuit	(PWR_OK)	(Vin FAIL_1, 2), (FAN ALARM_1, 2), (FAN M_S), (UNIT FAIL_1, 2)	(UNIT_IN)



Internal Structure of Primary Unit

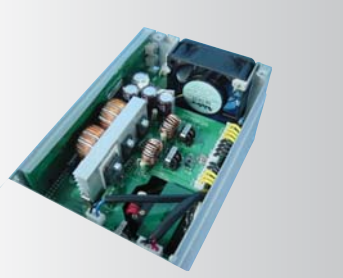

Internal Structure of Secondary Unit

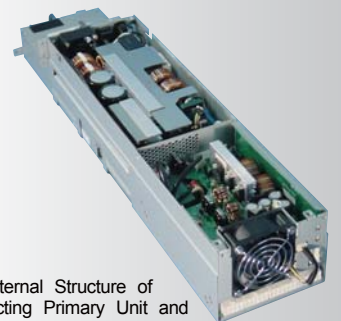

The Internal Structure of Connecting Primary Unit and Secondary Unit

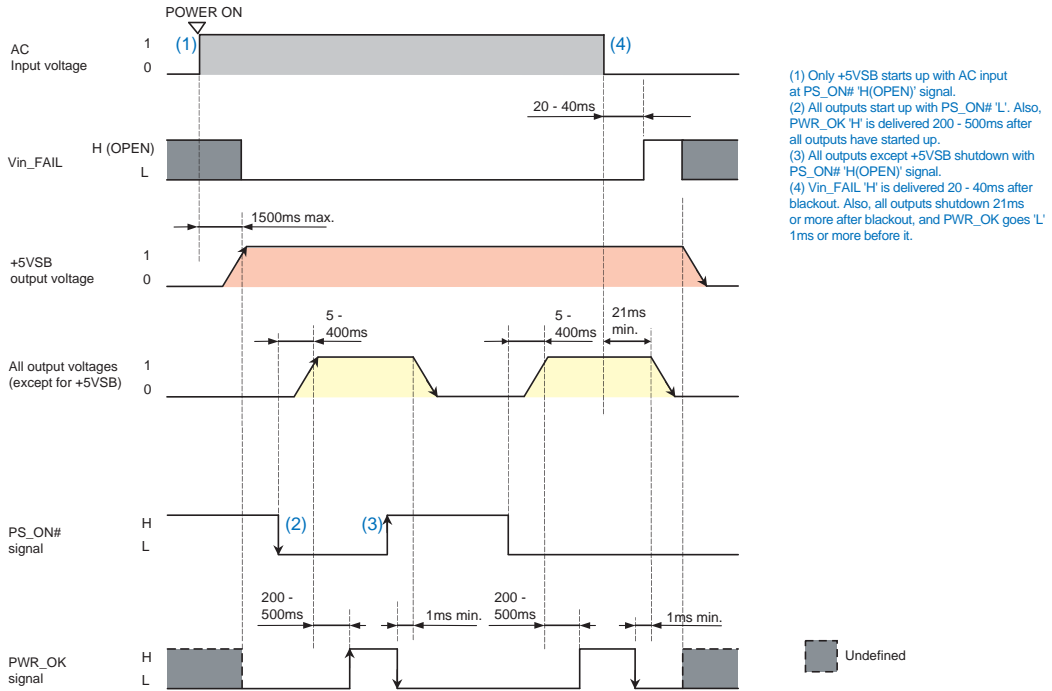

Sequence Diagram

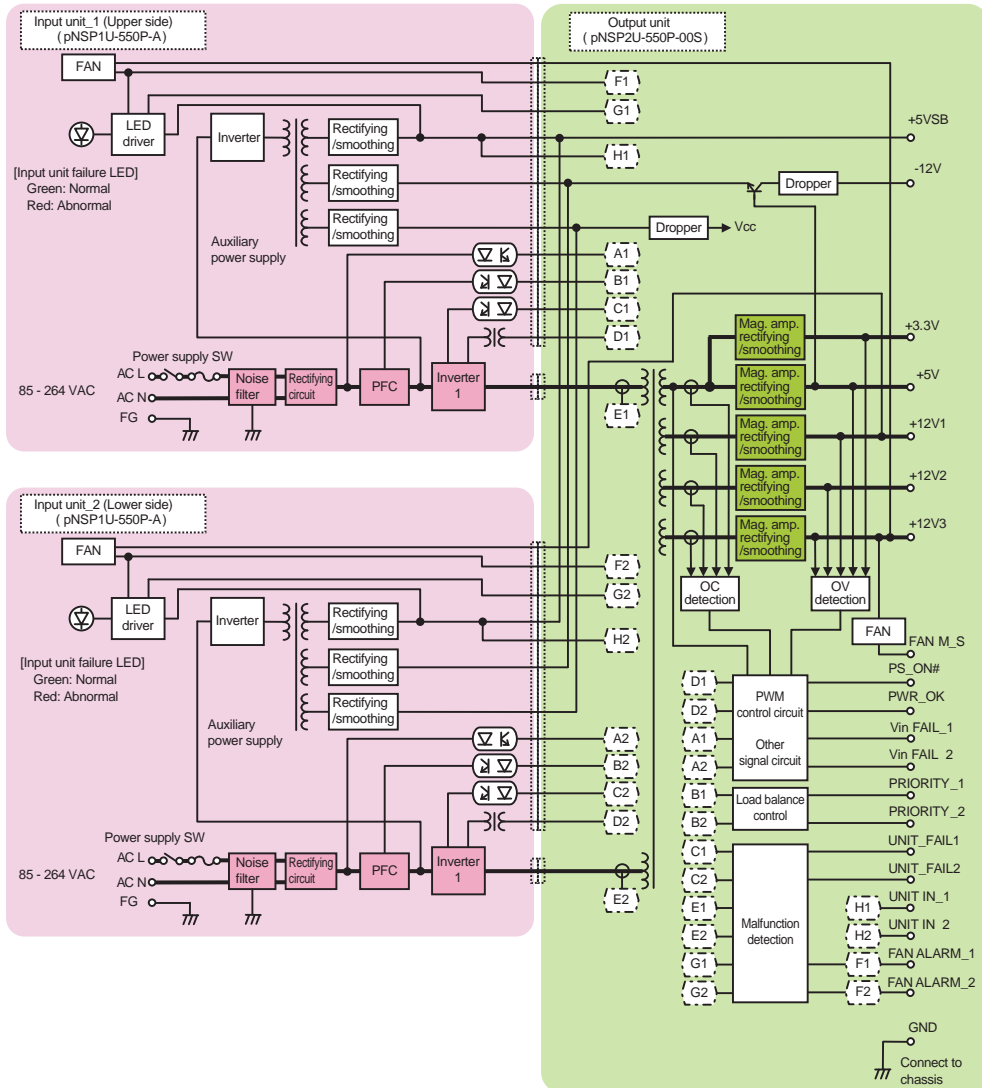

Block Diagram



Optional Components Sold Separately

Module			
Picture	Model	Type	Description
	pNSP1U-550P-A	Primary AC input unit	pNSP2U-550P-AAS is equipped with two units as standard.
	pNSP1U-550P-P	Dummy input unit	In the long term operation with only one input unit, pNSP1U-550P-A, install the dummy Input unit to the other side where pNSP1U-550P-A is not connected (upper or lower side).

Cable			
Picture	Model	Type	Description
	WH2753-02	AC power cord	125 VAC 12A (tracking resistance type) [PSE]

* Please contact us for products compatible with the AC power cord retention clamp.

Other Optional Components			
Model	Description	Model	Description
ACC2637	Automatic startup unit	WH5105	12V 4-pin connector conversion harness (80mm)
WH2820	20-pin extension harness (600mm)	WH5105-02	12V 4-pin connector conversion harness (320mm)
WH2747	20-pin extension harness (450mm)	WH5055	AT connector conversion harness
WH2892-02	20-pin extension harness (200mm)	ACC5046	Harness with PS_ON switch
WH2812	PCI-E 6-pin connector conversion harness	ACC5077	PS_ON terminal short connector
		WH5073	PS_ON terminal short 20-pin harness

Input Structure

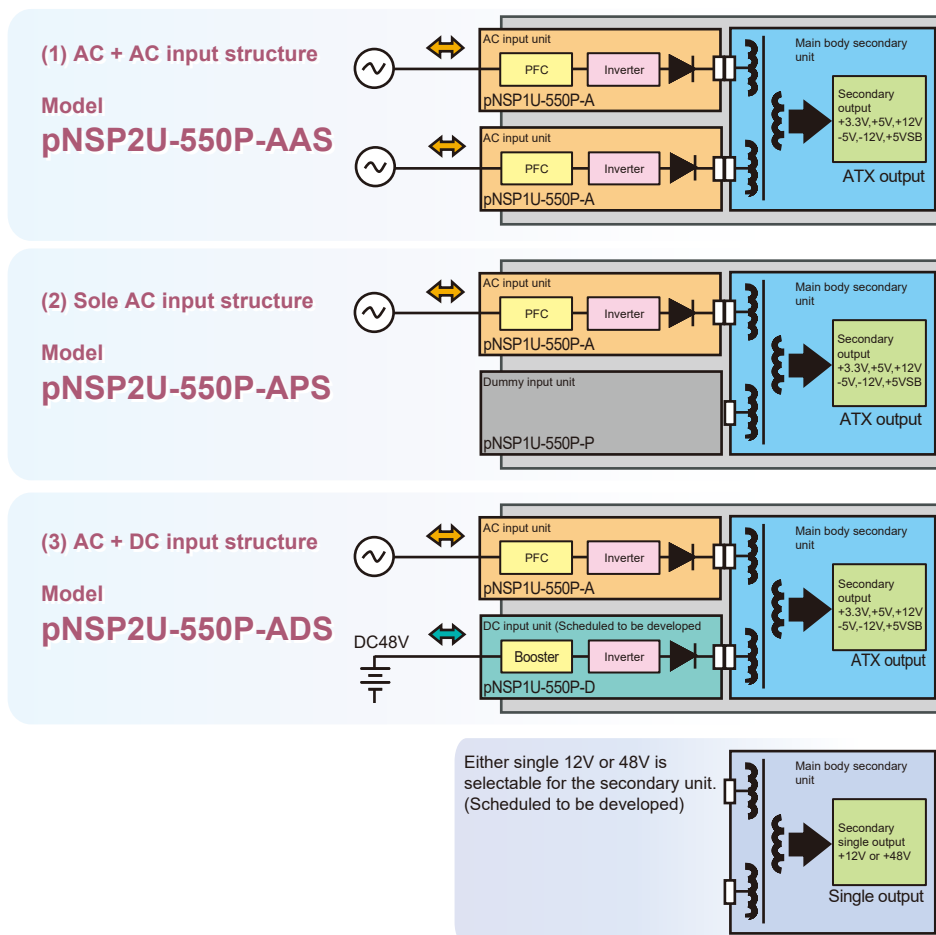

Characteristics Data (Examples of actual measurement)

● Fig.4 Efficiency / Input Current vs. Output Power

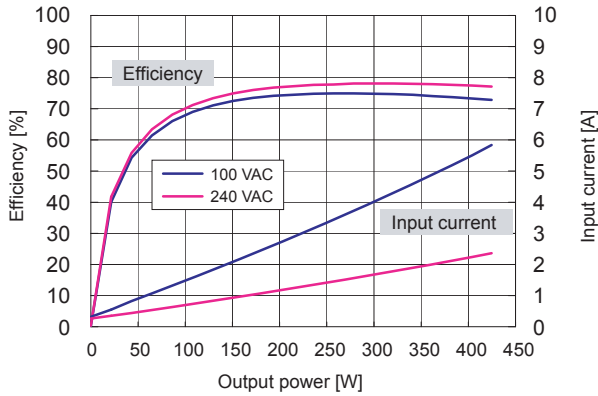

● Fig.5 Power Factor / Input VA vs. Output Power

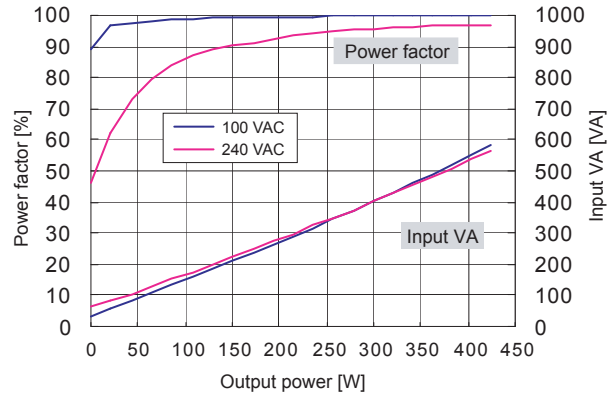

● Fig.6 Inrush Current

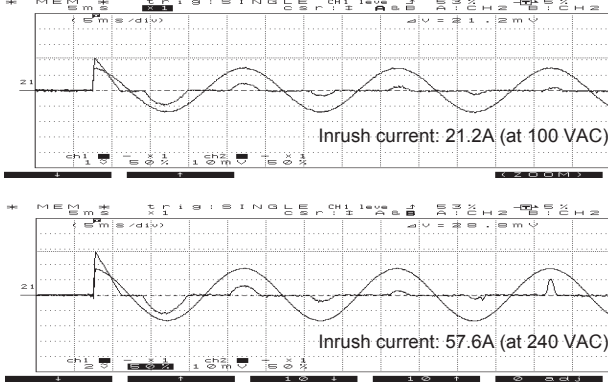

● Fig.7 Leakage Current

Input: 100 / 240 VAC
Load: Rated and min. load

	Rated load	Min. load
100 VAC	0.25mA	0.20mA
240 VAC	0.45mA	0.44mA

● Fig.8 Conducted Emission at 100 VAC

Input: 100 VAC
Load: Rated
Mode: Peak

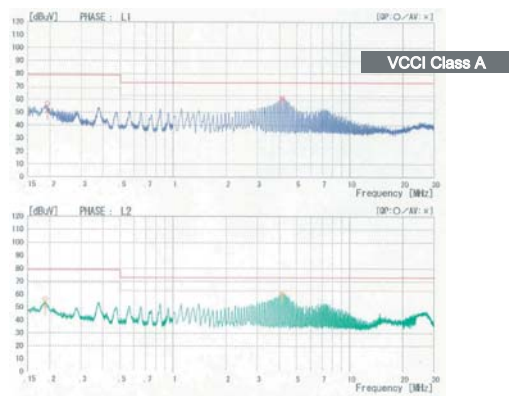

● Fig.9 Conducted Emission at 240 VAC

Input: 240 VAC
Load: Rated
Mode: Peak

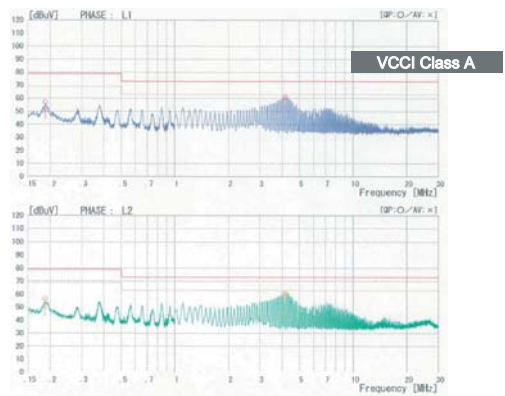

● Fig.10 Rising Characteristics at 100 VAC

Input: 100 VAC
Load: Rated
Time axis: 2ms/DIV

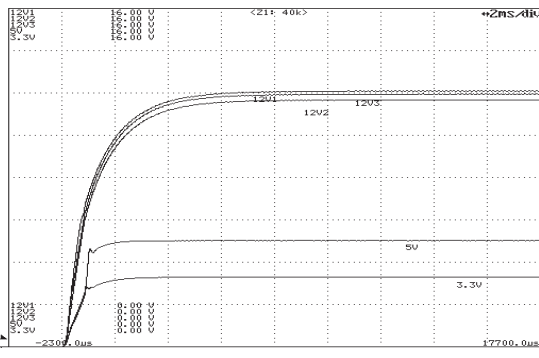

● Fig.11 Falling Characteristics at 100 VAC when REMOTE goes Off

Input: 100 VAC
Load: Rated
Time axis: 10ms/DIV

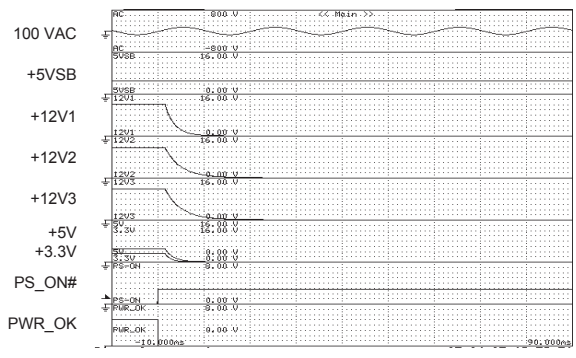

BRAIN Power Supply
Rack Mount Power Supply
Non-backup Power Supply

Characteristics Data (Examples of actual measurement)

● Fig.12 Rising Characteristics at 240 VAC

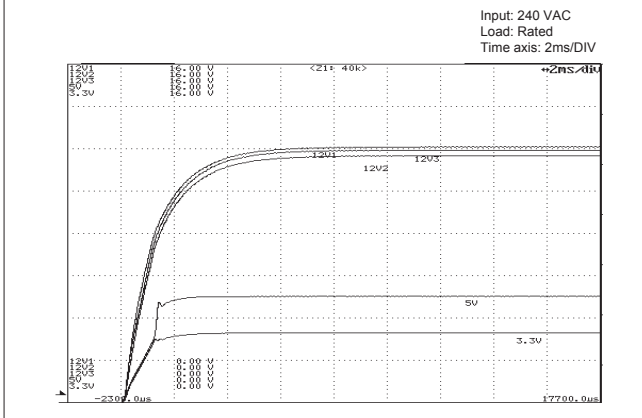

● Fig.13 Falling Characteristics at 240 VAC when REMOTE goes Off

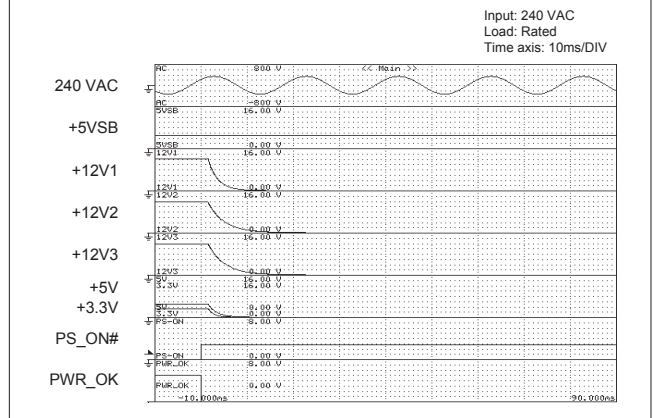

● Fig.14 Output Hold-up Time vs. Output Power

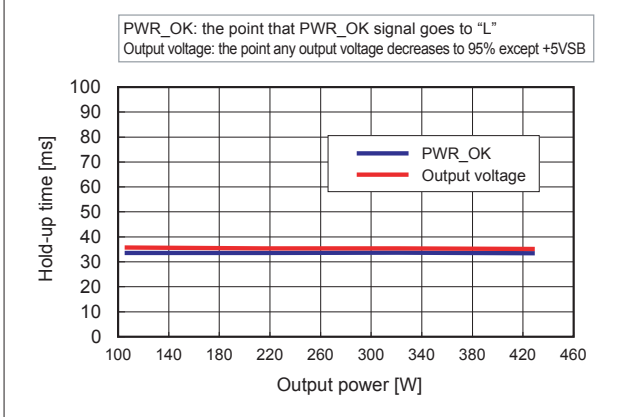

● Fig.15 Dynamic Load Fluctuation Characteristics at 1kHz

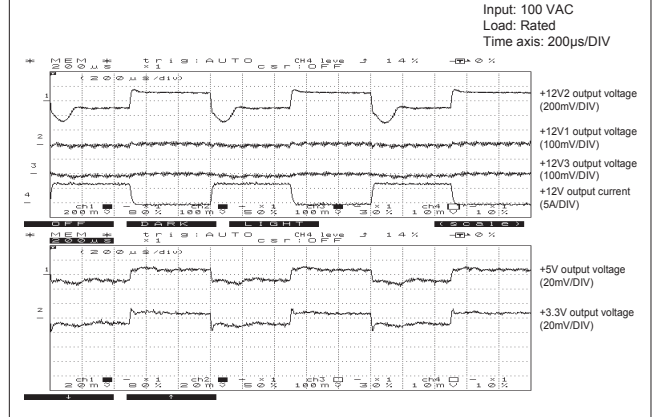

● Fig.16 Output Voltage Regulation

Output	Min. load	Rated load	Peak load
+12V1 output	0A	12A	18A
+12V2 output	0A	7A	12A
+12V3 output	0A	7A	10A
+5V output	0A	12A	20A
+3.3V output	0A	12A	20A

AC input voltage	85 VAC	100 VAC	132 VAC	176 VAC	240 VAC	264 VAC
+12V1 output (min. load)	12.279 V	12.278 V	12.278 V	12.278 V	12.278 V	12.278 V
+12V1 output (rated load)	12.054 V	12.051 V	12.050 V	12.050 V	12.049 V	12.049 V
+12V1 output (peak load)	11.941 V	11.938 V	11.937 V	11.937 V	11.936 V	11.936 V
+12V2 output (min. load)	12.080 V	12.079 V	12.079 V	12.079 V	12.079 V	12.079 V
+12V2 output (rated load)	11.894 V	11.894 V	11.894 V	11.893 V	11.894 V	11.893 V
+12V2 output (peak load)	11.810 V	11.810 V	11.809 V	11.809 V	11.809 V	11.809 V
+12V3 output (min. load)	12.044 V	12.043 V	12.042 V	12.043 V	12.043 V	12.042 V
+12V3 output (rated load)	11.887 V	11.885 V	11.885 V	11.885 V	11.885 V	11.886 V
+12V3 output (peak load)	11.768 V	11.767 V	11.768 V	11.767 V	11.767 V	11.766 V
+5V output (min. load)	5.151 V	5.151 V	5.151 V	5.151 V	5.151 V	5.151 V
+5V output (rated load)	5.020 V	5.020 V	5.021 V	5.021 V	5.021 V	5.021 V
+5V output (peak load)	4.978 V	4.978 V	4.978 V	4.978 V	4.978 V	4.978 V
+3.3V output (min. load)	3.398 V	3.398 V	3.398 V	3.398 V	3.398 V	3.398 V
+3.3V output (rated load)	3.301 V	3.301 V	3.301 V	3.301 V	3.301 V	3.301 V
+3.3V output (peak load)	3.274 V	3.274 V	3.274 V	3.274 V	3.274 V	3.274 V

● Fig.17 Ripple and Spike Voltage

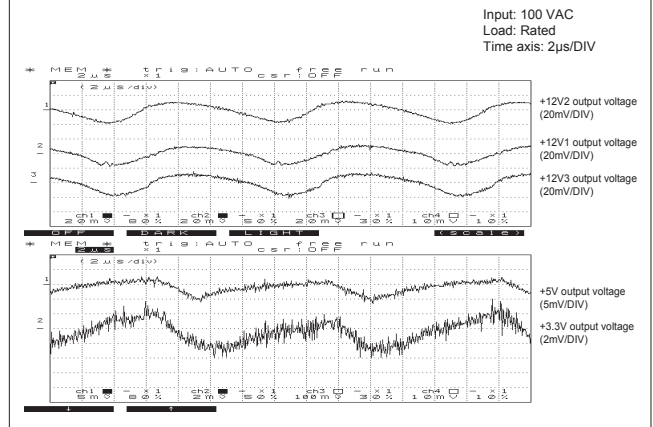

● Fig.18 Ambient Temperature vs. Expected Service Life

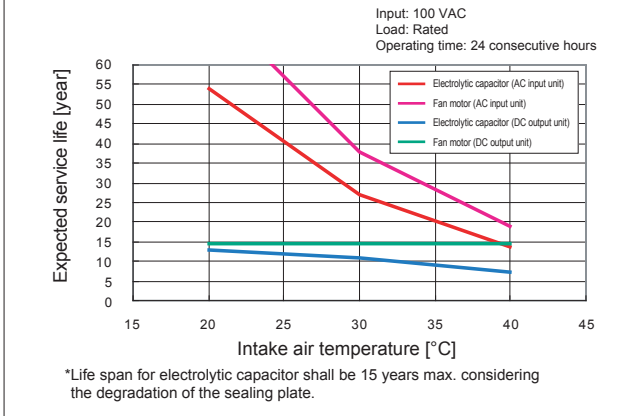

● Fig.19 Over Current Protection (V-I Characteristic)

